

## RADIALINIAI VENTILIATORIAI RFC; RFE

IP-55 Darbinė temperatūra: -30+85 °C, Ex -30+40 °C

**Žymėjimas:**

|   |           |                  |
|---|-----------|------------------|
| Z - cinkuotas plienas; E-dažytas                          | 1- 230 V  | 7 -680 aps/min   |
| Ex1 - sproгимui saugiam išpildyme                         | 3 - 400 V | 10 -960 aps/min  |
| Ex2 - FM - variklis su termistoriais                      |           | 15 -1450 aps/min |
| H - horizontalaus išpildymo                               |           | 30-2880 aps/min  |
| AKV1 - nerūdij. plienas A 304 maisto, farmacijos pramonei |           |                  |
| AKV2 - nerūdij. plienas A 316 chemijos pramonei           |           |                  |
| DB - ventiliatorius be antivibracinio pagrindo ir kojelių |           |                  |

*Greičio  
reguliatorius*

**RFC-200**

| Kodas  | Žymėjimas                          | V max. m <sup>3</sup> /h | Kaina EUR be PVM |
|--|------------------------------------|--------------------------|------------------|
| <b>RFC 200 - CINKUOTAS PLIENAS</b>   |                                    |                          |                  |
| 21210  | RFC 200-15/0,25-3-L-Z              | 1600                     | 326              |
| 21410  | RFC 200-15/0,25-3-L-Z-Ex1          | 1600                     | 651              |
| 832941   | RFC 200-15/0,25-3-L-Z-Ex1-FM       | 1600                     | 969              |
| 842719   | RFC 200-30A/1,5-3-L-Z-DB           | 2000                     | 410              |
| 838086   | RFC 200-15/0,25-3-L-Z-H            | 1600                     | 349              |
| 832022   | RFC 200-15/0,25-3-L-Z-Ex1-H        | 1600                     | 685              |
| 838103   | RFC 200-15/0,25-3-P-Z-Ex1-FM-H     | 1600                     | 992              |
| 838104   | RFC 200-15/0,25-3-L-Z-Ex1-FM-H     | 1600                     | 992              |
| 843059   | RFC 200-30A/1,5-3-L-Z-H            | 2000                     | 447              |
| 847062   | RFC 200-15/0,25-3-L-Z-HL           | 2000                     | 349              |
| 847042   | RFC 200-15/0,25-3-L-Z-Ex1-HL       | 1600                     | 685              |
| 847061   | RFC 200-15/0,25-3-L-Z-Ex1-FM-HL    | 1600                     | 992              |
| 847800   | RFC 200-30A/1,5-3-L-Z-HL           | 2000                     | 447              |
| <b>Nerūdijantis plienas - EN 10088/1-3-95 (AISI 304) maisto, farmacijos pramonei</b> |                                    |                          |                  |
| 21212  | RFC 200-15/0,25-3-L-AKV1           | 1600                     | 705              |
| 21413  | RFC 200-15/0,25-3-L-AKV1-Ex1       | 1600                     | 1142             |
| 837796   | RFC 200-15/0,25-3-L-AKV1-Ex1-FM    | 1600                     | 1437             |
| 842723   | RFC 200-30A/1,5-3-L-AKV1-DB        | 2000                     | 816              |
| 838090   | RFC 200-15/0,25-3-L-AKV1-H         | 1600                     | 781              |
| 832050   | RFC 200-15/0,25-3-L-AKV1-Ex1-H     | 1600                     | 1237             |
| 838108   | RFC 200-15/0,25-3-L-AKV1-Ex1-FM-H  | 1600                     | 1513             |
| 843063   | RFC 200-30A/1,5-3-L-AKV1-H         | 2000                     | 853              |
| 847057   | RFC 200-15/0,25-3-L-AKV1-HL        | 1600                     | 781              |
| 847044   | RFC 200-15/0,25-3-L-AKV1-Ex1-HL    | 1600                     | 1237             |
| 847056   | RFC 200-15/0,25-3-L-AKV1-Ex1-FM-HL | 1600                     | 1513             |
| 847804   | RFC 200-30A/1,5-3-L-AKV1-HL        | 2000                     | 853              |
| <b>Nerūdijantis plienas - EN 10088-95 (AISI 316) chemijos pramonei</b>               |                                    |                          |                  |
| 832549   | RFC 200-15/0,25-3-L-AKV2           | 1600                     | 770              |
| 832749   | RFC 200-15/0,25-3-L-AKV2-Ex1       | 1600                     | 1198             |
| 837798   | RFC 200-15/0,25-3-L-AKV2-Ex1-FM    | 1600                     | 1521             |
| 842725   | RFC 200-30A/1,5-3-L-AKV2-DB        | 2000                     | 816              |
| 838092   | RFC 200-15/0,25-3-L-AKV2-H         | 1600                     | 855              |
| 832756   | RFC 200-15/0,25-3-L-AKV2-Ex1-H     | 1600                     | 1300             |
| 838110   | RFC 200-15/0,25-3-L-AKV2-Ex1-FM-H  | 1600                     | 1607             |
| 843065   | RFC 200-30A/1,5-3-L-AKV2-H         | 2000                     | 927              |
| 847059   | RFC 200-15/0,25-3-L-AKV2-HL        | 1600                     | 855              |
| 847046   | RFC 200-15/0,25-3-L-AKV2-Ex1-HL    | 1600                     | 1300             |
| 847058   | RFC 200-15/0,25-3-L-AKV2-Ex1-FM-HL | 1600                     | 1607             |
| 847806   | RFC 200-30A/1,5-3-L-AKV2-HL        | 2000                     | 927              |
| <b>RFC 250 - CINKUOTAS PLIENAS</b>   |                                    |                          |                  |
| 22210  | RFC 250-15/0,37-3-L-Z              | 2200                     | 401              |
| 22410  | RFC 250-15/0,37-3-L-Z-Ex1          | 2200                     | 788              |
| 832943   | RFC 250-15/0,37-3-L-Z-Ex1-FM       | 2200                     | 1093             |

## AKV1

## AKV2

**RFC-250**

|                |  |                                    |      |             |
|----------------|--|------------------------------------|------|-------------|
|                | 838120   | RFC 250-15/0,37-3-L-Z-H            | 2200 | 431         |
|                | 832027   | RFC 250-15/0,37-3-L-Z-Ex1-H        | 2200 | <u>831</u>  |
|                | 838138   | RFC 250-15/0,37-3-L-Z-Ex1-FM-H     | 2200 | 1123        |
|                | 847102   | RFC 250-15/0,37-3-L-Z-HL           | 2200 | 431         |
|                | 847076   | RFC 250-15/0,37-3-L-Z-Ex1-HL       | 2200 | <u>831</u>  |
|                | 847101   | RFC 250-15/0,37-3-L-Z-Ex1-FM-HL    | 2200 | 1123        |
| <b>AKV1</b>    | <i>Nerūdijantis plienas - EN 10088/1-3-95 (AISI 304) maisto, farmācijas pramonei</i> |                                    |      |             |
|                | 22212  | RFC 250-15/0,37-3-L-AKV1           | 2200 | 930         |
|                | 22413  | RFC 250-15/0,37-3-L-AKV1-Ex1       | 2200 | <u>1469</u> |
|                | 837810   | RFC 250-15/0,37-3-L-AKV1-Ex1-FM    | 2200 | 1763        |
|                | 838124   | RFC 250-15/0,37-3-L-AKV1-H         | 2200 | 1031        |
|                | 832052   | RFC 250-15/0,37-3-L-AKV1-Ex1-H     | 2200 | <u>1591</u> |
|                | 838142   | RFC 250-15/0,37-3-L-AKV1-Ex1-FM-H  | 2200 | 1863        |
|                | 847097   | RFC 250-15/0,37-3-L-AKV1-HL        | 2200 | 1031        |
|                | 847078   | RFC 250-15/0,37-3-L-AKV1-Ex1-HL    | 2200 | <u>1591</u> |
|                | 847096   | RFC 250-15/0,37-3-L-AKV1-Ex1-FM-HL | 2200 | 1863        |
| <b>AKV2</b>    | <i>Nerūdijantis plienas - EN 10088-95 (AISI 316) chemijas pramonei</i>               |                                    |      |             |
|                | 832758   | RFC 250-15/0,37-3-L-AKV2           | 2200 | 1021        |
|                | 832762   | RFC 250-15/0,37-3-L-AKV2-Ex1       | 2200 | <u>1611</u> |
|                | 837812   | RFC 250-15/0,37-3-L-AKV2-Ex1-FM    | 2200 | 1881        |
|                | 838126   | RFC 250-15/0,37-3-L-AKV2-H         | 2200 | 1134        |
|                | 832939   | RFC 250-15/0,37-3-L-AKV2-Ex1-H     | 2200 | <u>1747</u> |
|                | 838144   | RFC 250-15/0,37-3-L-AKV2-Ex1-FM-H  | 2200 | 1994        |
|                | 847099   | RFC 250-15/0,37-3-L-AKV2-HL        | 2200 | 1134        |
|                | 847080   | RFC 250-15/0,37-3-L-AKV2-Ex1-HL    | 2200 | <u>1747</u> |
|                | 847098   | RFC 250-15/0,37-3-L-AKV2-Ex1-FM-HL | 2200 | 1994        |
| <b>RFC-280</b> | <b>RFC 280 - CINKUOTAS PLIENAS</b>   |                                    |      |             |
|                | 22540  | RFC 280-10/0,55-3-L-Z              | 2700 | 507         |
|                | 22541  | RFC 280-10/0,55-3-L-Z-Ex1          | 2700 | <u>979</u>  |
|                | 832945   | RFC 280-10/0,55-3-L-Z-Ex1-FM       | 2700 | 1302        |
|                | 22550  | RFC 280-15/1,5-3-L-Z               | 4500 | 583         |
|                | 22551  | RFC 280-15/1,35-3-L-Z-Ex1          | 3400 | <u>1048</u> |
|                | 832947   | RFC 280-15/1,5-3-L-Z-Ex1-FM        | 4500 | 1466        |
|                | 838146   | RFC 280-10/0,55-3-L-Z-H            | 2700 | 554         |
|                | 830696   | RFC 280-10/0,55-3-L-Z-Ex1-H        | 2700 | <u>1047</u> |
|                | 838164   | RFC 280-10/0,55-3-L-Z-Ex1-FM-H     | 2700 | 1350        |
|                | 838172   | RFC 280-15/1,5-3-L-Z-H             | 4500 | 632         |
|                | 830005   | RFC 280-15/1,35-3-L-Z-Ex1-H        | 3400 | <u>1115</u> |
|                | 838190   | RFC 280-15/1,5-3-L-Z-Ex1-FM-H      | 4500 | 1514        |
|                | 847134   | RFC 280-10/0,55-3-L-Z-HL           | 2700 | 554         |
|                | 847110   | RFC 280-10/0,55-3-L-Z-Ex1-HL       | 2700 | <u>1047</u> |
|                | 847133   | RFC 280-10/0,55-3-L-Z-Ex1-FM-HL    | 2700 | 1350        |
|                | 847154   | RFC 280-15/1,5-3-L-Z-HL            | 4500 | 632         |
|                | 847112   | RFC 280-15/1,35-3-L-Z-Ex1-HL       | 3400 | <u>1115</u> |
|                | 847153   | RFC 280-15/1,5-3-L-Z-Ex1-FM-HL     | 4500 | 1514        |
| <b>AKV1</b>    | <i>Nerūdijantis plienas - EN 10088/1-3-95 (AISI 304) maisto, farmācijas pramonei</i> |                                    |      |             |
|                | 22542  | RFC 280-10/0,55-3-L-AKV1           | 2700 | 1178        |
|                | 22543  | RFC 280-10/0,55-3-L-AKV1-Ex1       | 2700 | <u>1857</u> |
|                | 837824   | RFC 280-10/0,55-3-L-AKV1-Ex1-FM    | 2700 | 2150        |
|                | 22552  | RFC 280-15/1,5-3-L-AKV1            | 4500 | 1240        |
|                | 22553  | RFC 280-15/1,35-3-L-AKV1-Ex1       | 3400 | <u>1916</u> |
|                | 837838   | RFC 280-15/1,5-3-L-AKV1-Ex1-FM     | 3400 | 2314        |
|                | 838150   | RFC 280-10/0,55-3-L-AKV1-H         | 2700 | 1332        |
|                | 831099   | RFC 280-10/0,55-3-L-AKV1-Ex1-H     | 2700 | 2050        |
|                | 838168   | RFC 280-10/0,55-3-L-AKV1-Ex1-FM-H  | 2700 | 2311        |
|                | 838176   | RFC 280-15/1,5-3-L-AKV1-H          | 4500 | 1401        |
|                | 831101   | RFC 280-15/1,35-3-L-AKV1-Ex1-H     | 3400 | 2109        |



AKV2

|        |                                    |      |      |
|--------|------------------------------------|------|------|
| 838194 | RFC 280-15/1,5-3-L-AKV1-Ex1-FM-H   | 3400 | 2475 |
| 847129 | RFC 280-10/0,55-3-L-AKV1-HL        | 2700 | 1332 |
| 847114 | RFC 280-10/0,55-3-L-AKV1-Ex1-HL    | 2700 | 2050 |
| 847128 | RFC 280-10/0,55-3-L-AKV1-Ex1-FM-HL | 2700 | 2311 |
| 847149 | RFC 280-15/1,5-3-L-AKV1-HL         | 4500 | 1401 |
| 847116 | RFC 280-15/1,35-3-L-AKV1-Ex1-HL    | 3400 | 2109 |
| 847148 | RFC 280-15/1,5-3-L-AKV1-Ex1-FM-HL  | 4500 | 2475 |

**Nerūdjantis plienas - EN 10088-95 (AISI 316) chemijos pramonei**

|        |                                    |      |      |
|--------|------------------------------------|------|------|
| 832770 | RFC 280-10/0,55-3-L-AKV2           | 2700 | 1293 |
| 832774 | RFC 280-10/0,55-3-L-AKV2-Ex1       | 2700 | 2037 |
| 837826 | RFC 280-10/0,55-3-L-AKV2-Ex1-FM    | 2700 | 2300 |
| 832573 | RFC 280-15/1,5-3-L-AKV2            | 4500 | 1355 |
| 832772 | RFC 280-15/1,35-3-L-AKV2-Ex1       | 3400 | 2096 |
| 837840 | RFC 280-15/1,5-3-L-AKV2-Ex1-FM     | 4500 | 2464 |
| 838152 | RFC 280-10/0,55-3-L-AKV2-H         | 2700 | 1466 |
| 832781 | RFC 280-10/0,55-3-L-AKV2-Ex1-H     | 2700 | 2253 |
| 838170 | RFC 280-10/0,55-3-L-AKV2-Ex1-FM-H  | 2700 | 2480 |
| 838178 | RFC 280-15/1,5-3-L-AKV2-H          | 4500 | 1535 |
| 832783 | RFC 280-15/1,35-3-L-AKV2-Ex1-H     | 3400 | 2312 |
| 838196 | RFC 280-15/1,5-3-L-AKV2-Ex1-FM-H   | 4500 | 2644 |
| 847131 | RFC 280-10/0,55-3-L-AKV2-HL        | 2700 | 1466 |
| 847118 | RFC 280-10/0,55-3-L-AKV2-Ex1-HL    | 2700 | 2253 |
| 847130 | RFC 280-10/0,55-3-L-AKV2-Ex1-FM-HL | 2700 | 2480 |
| 847151 | RFC 280-15/1,5-3-L-AKV2-HL         | 4500 | 1535 |
| 847120 | RFC 280-15/1,35-3-L-AKV2-Ex1-HL    | 3400 | 2312 |
| 847150 | RFC 280-15/1,5-3-L-AKV2-Ex1-FM-HL  | 4500 | 2644 |



RFC-315

**RFC 315 - CINKUOTAS PLIENAS**

|        |                                |      |      |
|--------|--------------------------------|------|------|
| 23310  | RFC 315-10/1,1-3-L-Z           | 4600 | 678  |
| 23410  | RFC 315-10/0,95-3-L-Z-Ex1      | 4200 | 1111 |
| 832949 | RFC 315-10/1,1-3-L-Z-Ex1-FM    | 4200 | 1564 |
| 23210  | RFC 315-15/1,5-3-L-Z           | 5500 | 663  |
| 23510  | RFC 315-15/1,35-3-L-Z-Ex1      | 3400 | 1077 |
| 832951 | RFC 315-15/1,5-3-L-Z-Ex1-FM    | 3400 | 1546 |
| 838198 | RFC 315-10/1,1-3-L-Z-H         | 4600 | 748  |
| 830698 | RFC 315-10/0,95-3-L-Z-Ex1-H    | 4200 | 1202 |
| 838216 | RFC 315-10/1,1-3-L-Z-Ex1-FM-H  | 4200 | 1633 |
| 838224 | RFC 315-15/1,5-3-L-Z-H         | 5500 | 733  |
| 830009 | RFC 315-15/1,35-3-L-Z-Ex1-H    | 3400 | 1167 |
| 838242 | RFC 315-15/1,5-3-L-Z-Ex1-FM-H  | 3400 | 1616 |
| 847186 | RFC 315-10/1,1-3-L-Z-HL        | 4600 | 748  |
| 847162 | RFC 315-10/0,95-3-L-Z-Ex1-HL   | 4200 | 1202 |
| 847185 | RFC 315-10/1,1-3-L-Z-Ex1-FM-HL | 4200 | 1633 |
| 847206 | RFC 315-15/1,5-3-L-Z-HL        | 5500 | 733  |
| 847164 | RFC 315-15/1,35-3-L-Z-Ex1-HL   | 3400 | 1167 |
| 847205 | RFC 315-15/1,5-3-L-Z-Ex1-FM-HL | 3400 | 1616 |

AKV1

**Nerūdjantis plienas - EN 10088/1-3-95 (AISI 304) maisto, farmacijos pramonei**

|        |                                  |      |      |
|--------|----------------------------------|------|------|
| 23312  | RFC 315-10/1,1-3-L-AKV1          | 4600 | 1417 |
| 23413  | RFC 315-10/0,95-3-L-AKV1-Ex1     | 4200 | 2109 |
| 837852 | RFC 315-10/1,1-3-L-AKV1-Ex1-FM   | 4200 | 2543 |
| 23212  | RFC 315-15/1,5-3-L-AKV1          | 5500 | 1402 |
| 23513  | RFC 315-15/1,35-3-L-AKV1-Ex1     | 3400 | 2079 |
| 837866 | RFC 315-15/1,5-3-L-AKV1-Ex1-FM   | 3400 | 2525 |
| 838202 | RFC 315-10/1,1-3-L-AKV1-H        | 4600 | 1649 |
| 831103 | RFC 315-10/0,95-3-L-AKV1-Ex1-H   | 4200 | 2376 |
| 838220 | RFC 315-10/1,1-3-L-AKV1-Ex1-FM-H | 4200 | 2775 |
| 838228 | RFC 315-15/1,5-3-L-AKV1-H        | 5500 | 1634 |
| 831105 | RFC 315-15/1,35-3-L-AKV1-Ex1-H   | 3400 | 2345 |
| 838246 | RFC 315-15/1,5-3-L-AKV1-Ex1-FM-H | 3400 | 2757 |



AKV2

|  |                                   |      |             |
|--|-----------------------------------|------|-------------|
| 847181   | RFC 315-10/1,1-3-L-AKV1-HL        | 4600 | 1649        |
| 847166   | RFC 315-10/0,95-3-L-AKV1-Ex1-HL   | 4200 | <u>2376</u> |
| 847180   | RFC 315-10/1,1-3-L-AKV1-Ex1-FM-HL | 4200 | 2775        |
| 847201   | RFC 315-15/1,5-3-L-AKV1-HL        | 5500 | 1634        |
| 847168   | RFC 315-15/1,35-3-L-AKV1-Ex1-HL   | 3400 | <u>2345</u> |
| 847200   | RFC 315-15/1,5-3-L-AKV1-Ex1-FM-HL | 3400 | 2757        |
| <b>Nerūdijantis plienas - EN 10088-95 (AISI 316) chemijos pramonei</b> |                                   |      |             |
| 832787   | RFC 315-10/1,1-3-L-AKV2           | 4600 | 1551        |
| 832790   | RFC 315-10/0,95-3-L-AKV2-Ex1      | 4200 | <u>2310</u> |
| 837854   | RFC 315-10/1,1-3-L-AKV2-Ex1-FM    | 4200 | 2718        |
| 832785   | RFC 315-15/1,5-3-L-AKV2           | 5500 | 1537        |
| 831977   | RFC 315-15/1,35-3-L-AKV2-Ex1      | 3400 | <u>2280</u> |
| 837868   | RFC 315-15/1,5-3-L-AKV2-Ex1-FM    | 3400 | 2700        |
| 838204   | RFC 315-10/1,1-3-L-AKV2-H         | 4600 | 1811        |
| 832799   | RFC 315-10/0,95-3-L-AKV2-Ex1-H    | 4200 | <u>2609</u> |
| 838222   | RFC 315-10/1,1-3-L-AKV2-Ex1-FM-H  | 4200 | 2978        |
| 838230   | RFC 315-15/1,5-3-L-AKV2-H         | 5500 | 1797        |
| 832797   | RFC 315-15/1,35-3-L-AKV2-Ex1-H    | 3400 | <u>2579</u> |
| 838248   | RFC 315-15/1,5-3-L-AKV2-Ex1-FM-H  | 3400 | 2960        |
| 847183   | RFC 315-10/1,1-3-L-AKV2-HL        | 4600 | 1811        |
| 847170   | RFC 315-10/0,95-3-L-AKV2-Ex1-HL   | 4200 | <u>2609</u> |
| 847182   | RFC 315-10/1,1-3-L-AKV2-Ex1-FM-HL | 4200 | 2978        |
| 847203   | RFC 315-15/1,5-3-L-AKV2-HL        | 5500 | 1797        |
| 847172   | RFC 315-15/1,35-3-L-AKV2-Ex1-HL   | 3400 | <u>2579</u> |
| 847202   | RFC 315-15/1,5-3-L-AKV2-Ex1-FM-HL | 3400 | 2960        |



RFC-355

| <b>RFC 355 - CINKUOTAS PLIENAS</b> |                               |      |             |
|------------------------------------|-------------------------------|------|-------------|
| 24540                              | RFC 355-10/1,5-3-L-Z          | 5500 | 797         |
| 24541                              | RFC 355-10/1,3-3-L-Z-Ex1      | 5500 | <u>1258</u> |
| 832953                             | RFC 355-10/1,5-3-L-Z-Ex1-FM   | 5500 | 1833        |
| 837884                             | RFC 355-10/2,2-3-L-Z          | 6500 | 889         |
| 837892                             | RFC 355-10/1,9-3-L-Z-Ex1      | 6500 | <u>1403</u> |
| 837908                             | RFC 355-10/2,2-3-L-Z-Ex1-FM   | 6500 | 1995        |
| 24550                              | RFC 355-15/3-3-L-Z            | 7500 | 841         |
| 24551                              | RFC 355-15/2,5-3-L-Z-Ex1      | 5500 | <u>1309</u> |
| 832955                             | RFC 355-15/3-3-L-Z-Ex1-FM     | 5500 | 1899        |
| 843027                             | RFC 355-15A/4-3-L-Z           | 8500 | 932         |
| 843035                             | RFC 355-15A/3,6-3-L-Z-Ex1     | 8000 | <u>1465</u> |
| 843051                             | RFC 355-15A/4-3-L-Z-Ex1-FM    | 8000 | 2018        |
| 832399                             | RFC 355-15/4-3-L-Z            | 8000 | 932         |
| 832405                             | RFC 355-15/3,6-3-L-Z-Ex1      | 7500 | <u>1465</u> |
| 832957                             | RFC 355-15/4-3-L-Z-Ex1-FM     | 7500 | 2018        |
| 838250                             | RFC 355-10/1,5-3-L-Z-H        | 5500 | 878         |
| 830700                             | RFC 355-10/1,3-3-L-Z-Ex1-H    | 5500 | <u>1359</u> |
| 838268                             | RFC 355-10/1,5-3-L-Z-Ex1-FM-H | 5500 | 1914        |
| 838276                             | RFC 355-10/2,2-3-L-Z-H        | 6500 | 970         |
| 838284                             | RFC 355-10/1,9-3-L-Z-Ex1-H    | 6500 | <u>1503</u> |
| 838300                             | RFC 355-10/2,2-3-L-Z-Ex1-FM-H | 6500 | 2075        |
| 838308                             | RFC 355-15/3-3-L-Z-H          | 7500 | 922         |
| 830100                             | RFC 355-15/2,5-3-L-Z-Ex1-H    | 5500 | <u>1410</u> |
| 838326                             | RFC 355-15/3-3-L-Z-Ex1-FM-H   | 5500 | 1980        |
| 843067                             | RFC 355-15A/4-3-L-Z-H         | 8500 | 1012        |
| 843075                             | RFC 355-15A/3,6-3-L-Z-Ex1-H   | 8000 | <u>1566</u> |
| 843091                             | RFC 355-15A/4-3-L-Z-Ex1-FM-H  | 8000 | 2099        |
| 838334                             | RFC 355-15/4-3-L-Z-H          | 8500 | 1012        |
| 832801                             | RFC 355-15/3,6-3-L-Z-Ex1-H    | 7500 | <u>1566</u> |
| 838352                             | RFC 355-15/4-3-L-Z-Ex1-FM-H   | 7500 | 2099        |
| 847244                             | RFC 355-10/1,5-3-L-Z-HL       | 5500 | 878         |
| 847214                             | RFC 355-10/1,3-L-Z-Ex1-HL     | 5500 | <u>1359</u> |



|  |                                   |      |      |
|--|-----------------------------------|------|------|
| 847243   | RFC 355-10/1,5-3-L-Z-Ex1-FM-HL    | 5500 | 1914 |
| 847270   | RFC 355-10/2,2-3-L-Z-HL           | 6500 | 970  |
| 847260   | RFC 355-10/1,9-3-L-Z-Ex1-HL       | 6500 | 1503 |
| 847269   | RFC 355-10/2,2-3-L-Z-Ex1-FM-HL    | 6500 | 2075 |
| 847296   | RFC 355-15/3-3-L-Z-HL             | 7500 | 922  |
| 847216   | RFC 355-15/2,5-3-L-Z-Ex1-HL       | 5500 | 1410 |
| 847295   | RFC 355-15/3-3-L-Z-Ex1-FM-HL      | 5500 | 1980 |
| 847324   | RFC 355-15A/4-3-L-Z-HL            | 8500 | 1012 |
| 847332   | RFC 355-15A/3,6-3-L-Z-Ex1-HL      | 8000 | 1566 |
| 847323   | RFC 355-15A/4-3-L-Z-Ex1-FM-HL     | 8000 | 2099 |
| 847310   | RFC 355-15/4-3-L-Z-HL             | 8000 | 1012 |
| 847218   | RFC 355-15/3,6-3-L-Z-Ex1-HL       | 7500 | 1566 |
| 847309   | RFC 355-15/4-3-L-Z-Ex1-FM-HL      | 8000 | 2099 |
| <b>Nerūdijantis plienas - EN 10088/1-3-95 (AISI 304) maisto, farmacijos pramonei</b> |                                   |      |      |
| 24542  | RFC 355-10/1,5-3-L-AKV1           | 5500 | 1642 |
| 24543  | RFC 355-10/1,3-3-L-AKV1-Ex1       | 5500 | 2371 |
| 837880   | RFC 355-10/1,5-3-L-AKV1-Ex1-FM    | 5500 | 2889 |
| 837888   | RFC 355-10/2,2-3-L-AKV1           | 6500 | 1734 |
| 837896   | RFC 355-10/1,9-3-L-AKV1-Ex1       | 6500 | 2504 |
| 837912   | RFC 355-10/2,2-3-L-AKV1-Ex1-FM    | 6500 | 3050 |
| 24552  | RFC 355-15/3-3-L-AKV1             | 7500 | 1686 |
| 24553  | RFC 355-15/2,5-3-L-AKV1-Ex1       | 5500 | 2418 |
| 837926   | RFC 355-15/3-3-L-AKV1-Ex1-FM      | 7500 | 2954 |
| 843031   | RFC 355-15A/4-3-L-AKV1            | 8500 | 1776 |
| 843039   | RFC 355-15A/3,6-3-L-AKV1-Ex1      | 8000 | 2562 |
| 843055   | RFC 355-15A/4-3-L-AKV1-Ex1-FM     | 8000 | 3074 |
| 832411   | RFC 355-15/4-3-L-AKV1             | 8000 | 1776 |
| 832415   | RFC 355-15/3,6-3-L-AKV1-Ex1       | 7500 | 2562 |
| 837940   | RFC 355-15/4-3-L-AKV1-Ex1-FM      | 7500 | 3074 |
| 838254   | RFC 355-10/1,5-3-L-AKV1-H         | 5500 | 1909 |
| 831107   | RFC 355-10/1,3-3-L-AKV1-Ex1-H     | 5500 | 2679 |
| 838272   | RFC 355-10/1,5-3-L-AKV1-Ex1-FM-H  | 5500 | 3156 |
| 838280   | RFC 355-10/2,2-3-L-AKV1-H         | 6500 | 2001 |
| 838288   | RFC 355-10/1,9-3-L-AKV1-Ex1-H     | 6500 | 2811 |
| 838304   | RFC 355-10/2,2-3-L-AKV1-Ex1-FM-H  | 6500 | 3317 |
| 838312   | RFC 355-15/3-3-L-AKV1-H           | 7500 | 1953 |
| 831109   | RFC 355-15/2,5-3-L-AKV1-Ex1-H     | 5500 | 2725 |
| 838330   | RFC 355-15/3-3-L-AKV1-Ex1-FM-H    | 5500 | 3222 |
| 843071   | RFC 355-15A/4-3-L-AKV1-H          | 8500 | 2043 |
| 843079   | RFC 355-15A/3,6-3-L-AKV1-Ex1-H    | 8000 | 2869 |
| 843095   | RFC 355-15A/4-3-L-AKV1-Ex1-FM-H   | 8000 | 3341 |
| 838338   | RFC 355-15/4-3-L-AKV1-H           | 8500 | 2043 |
| 832813   | RFC 355-15/3,6-3-L-AKV1-Ex1-H     | 7500 | 2869 |
| 838356   | RFC 355-15/4-3-L-AKV1-Ex1-FM-H    | 7500 | 3341 |
| 847239   | RFC 355-10/1,5-3-L-AKV1-HL        | 5500 | 1909 |
| 847220   | RFC 355-10/1,3-3-L-AKV1-Ex1-HL    | 5500 | 2679 |
| 847238   | RFC 355-10/1,5-3-L-AKV1-Ex1-FM-HL | 5500 | 3156 |
| 847265   | RFC 355-10/2,2-3-L-AKV1-HL        | 6500 | 2001 |
| 847258   | RFC 355-10/1,9-3-L-AKV1-Ex1-HL    | 6500 | 2811 |
| 847264   | RFC 355-10/2,2-3-L-AKV1-Ex1-FM-HL | 6500 | 3317 |
| 847291   | RFC 355-15/3-3-L-AKV1-HL          | 7500 | 1953 |
| 847222   | RFC 355-15/2,5-3-L-AKV1-Ex1-HL    | 5500 | 2725 |
| 847290   | RFC 355-15/3-3-L-AKV1-Ex1-FM-HL   | 5500 | 3222 |
| 847319   | RFC 355-15A/4-3-L-AKV1-HL         | 8500 | 2043 |
| 847334   | RFC 355-15A/3,6-3-L-AKV1-Ex1-HL   | 8000 | 2869 |
| 847318   | RFC 355-15A/4-3-L-AKV1-Ex1-FM-HL  | 8000 | 3341 |
| 847305   | RFC 355-15/4-3-L-AKV1-HL          | 8000 | 2043 |
| 847224   | RFC 355-15/3,6-3-L-AKV1-Ex1-HL    | 7500 | 2869 |
| 847304   | RFC 355-15/4-3-L-AKV1-Ex1-FM-HL   | 8000 | 3341 |
| <b>Nerūdijantis plienas - EN 10088-95 (AISI 316) chemijos pramonei</b>               |                                   |      |      |
| 832816   | RFC 355-10/1,5-3-L-AKV2           | 5500 | 1796 |
| 832818   | RFC 355-10/1,3-3-L-AKV2-Ex1       | 5500 | 2593 |
| 837882   | RFC 355-10/1,5-3-L-AKV2-Ex1-FM    | 5500 | 3082 |
| 837890   | RFC 355-10/2,2-3-L-AKV2           | 6500 | 1888 |
| 837898   | RFC 355-10/1,9-3-L-AKV2-Ex1       | 6500 | 2726 |

AKV1



AKV2



|                                    |                                   |       |             |
|------------------------------------|-----------------------------------|-------|-------------|
| 837914                             | RFC 355-10/2,2-3-L-AKV2-Ex1-FM    | 6500  | 3243        |
| 832803                             | RFC 355-15/3-3-L-AKV2             | 7500  | 1840        |
| 832804                             | RFC 355-15/2,5-3-L-AKV2-Ex1       | 5500  | <u>2640</u> |
| 837928                             | RFC 355-15/3-3-L-AKV2-Ex1-FM      | 7500  | 3148        |
| 843033                             | RFC 355-15A/4-3-L-AKV2            | 8500  | 1931        |
| 843041                             | RFC 355-15A/3,6-3-L-AKV2-Ex1      | 8000  | <u>2784</u> |
| 843057                             | RFC 355-15A/4-3-L-AKV2-Ex1-FM     | 8000  | 3267        |
| 832806                             | RFC 355-15/4-3-L-AKV2             | 8000  | 1931        |
| 832808                             | RFC 355-15/3,6-3-L-AKV2-Ex1       | 7500  | <u>2784</u> |
| 837942                             | RFC 355-15/4-3-L-AKV2-Ex1-FM      | 7500  | 3267        |
| 838256                             | RFC 355-10/1,5-3-L-AKV2-H         | 5500  | 2096        |
| 832820                             | RFC 355-10/1,3-3-L-AKV2-Ex1-H     | 5500  | <u>2938</u> |
| 838274                             | RFC 355-10/1,5-3-L-AKV2-Ex1-FM-H  | 5500  | 3381        |
| 838282                             | RFC 355-10/2,2-3-L-AKV2-H         | 6500  | 2187        |
| 838290                             | RFC 355-10/1,9-3-L-AKV2-Ex1-H     | 6500  | <u>3070</u> |
| 838306                             | RFC 355-10/2,2-3-L-AKV2-Ex1-FM-H  | 6500  | 3542        |
| 838314                             | RFC 355-15/3-3-L-AKV2-H           | 7500  | 2139        |
| 832812                             | RFC 355-15/2,5-3-L-AKV2-Ex1-H     | 5500  | <u>2985</u> |
| 838332                             | RFC 355-15/3-3-L-AKV2-Ex1-FM-H    | 5500  | 3447        |
| 843073                             | RFC 355-15A/4-3-L-AKV2-H          | 8500  | 2230        |
| 843081                             | RFC 355-15A/3,6-3-L-AKV2-Ex1-H    | 8000  | <u>3128</u> |
| 843097                             | RFC 355-15A/4-3-L-AKV2-Ex1-FM-H   | 8000  | 3566        |
| 838340                             | RFC 355-15/4-3-L-AKV2-H           | 8500  | 2230        |
| 832810                             | RFC 355-15/3,6-3-L-AKV2-Ex1-H     | 7500  | <u>3128</u> |
| 838358                             | RFC 355-15/4-3-L-AKV2-Ex1-FM-H    | 7500  | 3566        |
| 847241                             | RFC 355-10/1,5-3-L-AKV2-HL        | 5500  | 2096        |
| 847226                             | RFC 355-10/1,3-3-L-AKV2-Ex1-HL    | 5500  | <u>2938</u> |
| 847240                             | RFC 355-10/1,5-3-L-AKV2-Ex1-FM-HL | 5500  | 3381        |
| 847267                             | RFC 355-10/2,2-3-L-AKV2-HL        | 6500  | 2187        |
| 847259                             | RFC 355-10/1,9-3-L-AKV2-Ex1-HL    | 6500  | <u>3070</u> |
| 847266                             | RFC 355-10/2,2-3-L-AKV2-Ex1-FM-HL | 6500  | 3542        |
| 847293                             | RFC 355-15/3-3-L-AKV2-HL          | 7500  | 2139        |
| 847228                             | RFC 355-15/2,5-L-AKV2-Ex1-HL      | 5500  | <u>2985</u> |
| 847292                             | RFC 355-15/3-3-L-AKV2-Ex1-FM-HL   | 5500  | 3447        |
| 847321                             | RFC 355-15A/4-3-L-AKV2-HL         | 8500  | 2230        |
| 847336                             | RFC 355-15A/3,6-3-L-AKV2-Ex1-HL   | 8000  | <u>3128</u> |
| 847320                             | RFC 355-15A/4-3-L-AKV2-Ex1-FM-HL  | 8000  | 3566        |
| 847307                             | RFC 355-15/4-3-L-AKV2-HL          | 8000  | 2230        |
| 847230                             | RFC 355-15/3,6-L-AKV2-Ex1-HL      | 7500  | <u>3128</u> |
| 847306                             | RFC 355-15/4-3-L-AKV2-Ex1-FM-HL   | 8000  | 3566        |
| <b>RFC 400 - CINKUOTAS PLIENAS</b> |                                   |       |             |
| 24110                              | RFC 400-10/1,5-3-L-Z              | 6000  | 902         |
| 24310                              | RFC 400-10/1,3-3-L-Z-Ex1          | 4500  | <u>1421</u> |
| 832959                             | RFC 400-10/1,5-3-L-Z-Ex1-FM       | 4000  | 1964        |
| 837974                             | RFC 400-10/2,2-3-L-Z              | 7200  | 994         |
| 837982                             | RFC 400-10/1,9-3-L-Z-Ex1          | 7000  | <u>1566</u> |
| 837998                             | RFC 400-10/2,2-3-L-Z-Ex1-FM       | 7200  | 2125        |
| 830753                             | RFC 400-15A/4-3-L-Z               | 7200  | 1036        |
| 830754                             | RFC 400-15A/3,6-3-L-Z-Ex1         | 6800  | <u>1629</u> |
| 832963                             | RFC 400-15A/4-3-L-Z-Ex1-FM        | 7200  | 2149        |
| 24610                              | RFC 400-15/4-3-L-Z                | 7200  | 1036        |
| 24710                              | RFC 400-15/3,6-3-L-Z-Ex1          | 6800  | <u>1629</u> |
| 832961                             | RFC 400-15/4-3-L-Z-Ex1-FM         | 7200  | 2149        |
| 836401                             | RFC 400-15/5,5-3-L-Z              | 8500  | 1177        |
| 842641                             | RFC 400-15A/7,5-3-L-Z             | 13500 | 1270        |
| 842649                             | RFC 400-15A/6,8-3-L-Z-Ex1         | 13500 | <u>2088</u> |
| 842665                             | RFC 400-15A/7,5-3-L-Z-Ex1-FM      | 13500 | 3103        |
| 838384                             | RFC 400-10/1,5-3-L-Z-H            | 6000  | 999         |

**RFC-400**

|  |                                  |       |             |
|--|----------------------------------|-------|-------------|
| 830704   | RFC 400-10/1,3-3-L-Z-Ex1-H       | 4500  | <u>1542</u> |
| 838402   | RFC 400-10/1,5-3-L-Z-Ex1-FM-H    | 4500  | 2061        |
| 838410   | RFC 400-10/2,2-3-L-Z-H           | 7200  | 1091        |
| 838418   | RFC 400-10/1,9-3-L-Z-Ex1-H       | 7000  | <u>1687</u> |
| 838434   | RFC 400-10/2,2-3-L-Z-Ex1-FM-H    | 7200  | 2222        |
| 838442   | RFC 400-15A/4-3-L-Z-H            | 7200  | 1133        |
| 830755   | RFC 400-15A/3,6-3-L-Z-Ex1-H      | 7200  | <u>1750</u> |
| 838460   | RFC 400-15A/4-3-L-Z-Ex1-FM-H     | 6800  | 2246        |
| 838468   | RFC 400-15/4-3-L-Z-H             | 7200  | 1133        |
| 830706   | RFC 400-15/3,6-3-L-Z-Ex1-H       | 6800  | <u>1750</u> |
| 838486   | RFC 400-15/4-3-L-Z-Ex1-FM-H      | 7200  | 2246        |
| 838494   | RFC 400-15/5,5-3-L-Z-H           | 8500  | 1274        |
| 842678   | RFC 400-15A/7,5-3-L-Z-H          | 15000 | 1367        |
| 842686   | RFC 400-15A/6,8-3-L-Z-Ex1-H      | 13500 | <u>2209</u> |
| 842702   | RFC 400-15A/7,5-3-L-Z-Ex1-FM-H   | 13500 | 3200        |
| 847374   | RFC 400-10/1,5-3-L-Z-HL          | 6000  | 999         |
| 847344   | RFC 400-10/1,3-3-L-Z-Ex1-HL      | 4500  | <u>1542</u> |
| 847373   | RFC 400-10/1,5-3-L-Z-Ex1-FM-HL   | 4500  | 2061        |
| 847400   | RFC 400-10/2,2-3-L-Z-HL          | 7200  | 1091        |
| 847390   | RFC 400-10/1,9-3-L-Z-Ex1-HL      | 7000  | <u>1687</u> |
| 847399   | RFC 400-10/2,2-3-L-Z-Ex1-FM-HL   | 7200  | 2222        |
| 847448   | RFC 400-15A/4-3-L-Z-HL           | 7200  | 1133        |
| 847348   | RFC 400-15A/3,6-3-L-Z-Ex1-HL     | 7200  | <u>1750</u> |
| 847447   | RFC 400-15A/4-3-L-Z-Ex1-FM-HL    | 6800  | 2246        |
| 847420   | RFC 400-15/4-3-L-Z-HL            | 7200  | 1133        |
| 847346   | RFC 400-15/3,6-3-L-Z-Ex1-HL      | 6800  | <u>1750</u> |
| 847419   | RFC 400-15/4-3-L-Z-Ex1-FM-HL     | 7200  | 2246        |
| 847431   | RFC 400-15/5,5-3-L-Z-HL          | 8500  | 1274        |
| 847468   | RFC 400-15A/7,5-3-L-Z-HL         | 15500 | 1367        |
| 847456   | RFC 400-15A/6,8-3-L-Z-Ex1-HL     | 13500 | <u>2209</u> |
| 847476   | RFC 400-15A/7,5-3-L-Z-Ex1-FM-HL  | 15500 | 3200        |
| <b>Nerūdijantis plienas - EN 10088/1-3-95 (AISI 304) maisto, farmācijas pramonei</b> |                                  |       |             |
| 24112  | RFC 400-10/1,5-3-L-AKV1          | 6000  | 1924        |
| 24313  | RFC 400-10/1,3-3-L-AKV1-Ex1      | 4500  | <u>2687</u> |
| 837970   | RFC 400-10/1,5-3-L-AKV1-Ex1-FM   | 4000  | 3163        |
| 837978   | RFC 400-10/2,2-3-L-AKV1          | 7200  | 2016        |
| 837986   | RFC 400-10/1,9-3-L-AKV1-Ex1      | 7000  | <u>2820</u> |
| 838002   | RFC 400-10/2,2-3-L-AKV1-Ex1-FM   | 7200  | 3324        |
| 830749   | RFC 400-15A/4-3-L-AKV1           | 7200  | 2059        |
| 830750   | RFC 400-15A/3,6-3-L-AKV1-Ex1     | 6800  | <u>2878</u> |
| 838016   | RFC 400-15A/4-3-L-AKV1-Ex1-FM    | 7200  | 3348        |
| 24612  | RFC 400-15/4-3-L-AKV1            | 7200  | 2059        |
| 24713  | RFC 400-15/3,6-3-L-AKV1-Ex1      | 6800  | <u>2878</u> |
| 838030   | RFC 400-15/4-3-L-AKV1-Ex1-FM     | 7200  | 3348        |
| 836406   | RFC 400-15/5,5-3-L-AKV1          | 8500  | 2199        |
| 842645   | RFC 400-15A/7,5-3-L-AKV1         | 13500 | 2293        |
| 842653   | RFC 400-15A/6,8-3-L-AKV1-Ex1     | 13500 | <u>3300</u> |
| 842669   | RFC 400-15A/7,5-3-L-AKV1-Ex1-FM  | 13500 | 4302        |
| 838388   | RFC 400-10/1,5-3-L-AKV1-H        | 6000  | 2246        |
| 831111   | RFC 400-10/1,3-3-L-AKV1-Ex1-H    | 4500  | <u>3057</u> |
| 838406   | RFC 400-10/1,5-3-L-AKV1-Ex1-FM-H | 4500  | 3485        |
| 838414   | RFC 400-10/2,2-3-L-AKV1-H        | 7200  | 2338        |
| 838422   | RFC 400-10/1,9-3-L-AKV1-Ex1-H    | 7000  | <u>3190</u> |
| 838438   | RFC 400-10/2,2-3-L-AKV1-Ex1-FM-H | 7200  | 3646        |
| 838446   | RFC 400-15A/4-3-L-AKV1-H         | 7200  | 2380        |
| 832827   | RFC 400-15A/3,6-3-L-AKV1-Ex1-H   | 7200  | <u>3247</u> |
| 838464   | RFC 400-15A/4-3-L-AKV1-Ex1-FM-H  | 6800  | 3670        |
| 838472   | RFC 400-15/4-3-L-AKV1-H          | 7200  | 2380        |

AKV1



|  |                                    |       |             |
|--|------------------------------------|-------|-------------|
| 831113   | RFC 400-15/3,6-3-L-AKV1-Ex1-H      | 6800  | <u>3247</u> |
| 838490   | RFC 400-15/4-3-L-AKV1-Ex1-FM-H     | 7200  | <u>3670</u> |
| 838498   | RFC 400-15/5,5-3-L-AKV1-H          | 8500  | <u>2521</u> |
| 842682   | RFC 400-15A/7,5-3-L-AKV1-H         | 15000 | <u>2614</u> |
| 842690   | RFC 400-15A/6,8-3-L-AKV1-Ex1-H     | 13500 | <u>3670</u> |
| 842706   | RFC 400-15A/7,5-3-L-AKV1-Ex1-FM-H  | 13500 | <u>4624</u> |
| 847369   | RFC 400-10/1,5-3-L-AKV1-HL         | 6000  | <u>2246</u> |
| 847350   | RFC 400-10/1,3-3-L-AKV1-Ex1-HL     | 4500  | <u>3057</u> |
| 847362   | RFC 400-10/1,2-3-L-AKV1-Ex2-FM-HL  | 4500  | <u>2926</u> |
| 847368   | RFC 400-10/1,5-3-L-AKV1-Ex1-FM-HL  | 7000  | <u>3485</u> |
| 847395   | RFC 400-10/2,2-3-L-AKV1-HL         | 7200  | <u>2338</u> |
| 847388   | RFC 400-10/1,9-3-L-AKV1-Ex1-HL     | 7200  | <u>3190</u> |
| 847382   | RFC 400-10/1,78-3-L-AKV1-Ex2-FM-HL | 7200  | <u>3049</u> |
| 847394   | RFC 400-10/2,2-3-L-AKV1-Ex1-FM-HL  | 7200  | <u>3646</u> |
| 847443   | RFC 400-15A/4-3-L-AKV1-HL          | 6800  | <u>2380</u> |
| 847354   | RFC 400-15A/3,6-3-L-AKV1-Ex1-HL    | 7200  | <u>3247</u> |
| 847436   | RFC 400-15A/3,3-3-L-AKV1-Ex2-FM-HL | 6800  | <u>3100</u> |
| 847442   | RFC 400-15A/4-3-L-AKV1-Ex1-FM-HL   | 7200  | <u>3670</u> |
| 847415   | RFC 400-15/4-3-L-AKV1-HL           | 8500  | <u>2380</u> |
| 847352   | RFC 400-15/3,6-3-L-AKV1-Ex1-HL     | 7000  | <u>3247</u> |
| 847408   | RFC 400-15/3,3-3-L-AKV1-Ex2-FM-HL  | 6800  | <u>3100</u> |
| 847414   | RFC 400-15/4-3-L-AKV1-Ex1-FM-HL    | 7200  | <u>3670</u> |
| 847428   | RFC 400-15/5,5-3-L-AKV1-HL         | 8000  | <u>2521</u> |
| 847472   | RFC 400-15A/7,5-3-L-AKV1-HL        | 15500 | <u>2614</u> |
| 847458   | RFC 400-15A/6,8-3-L-AKV1-Ex1-HL    | 15000 | <u>3670</u> |
| 847464   | RFC 400-15A/6,0-3-L-AKV1-Ex2-FM-HL | 13500 | <u>3503</u> |
| 847478   | RFC 400-15A/7,5-3-L-AKV1-Ex1-FM-HL | 15500 | <u>4624</u> |
| <b>Nerūdijantis plienas - EN 10088-95 (AISI 316) chemijos pramonei</b> |                                    |       |             |
| 832831   | RFC 400-10/1,5-3-L-AKV2            | 6000  | <u>2113</u> |
| 832837   | RFC 400-10/1,3-3-L-AKV2-Ex1        | 4500  | <u>2819</u> |
| 837972   | RFC 400-10/1,5-3-L-AKV2-Ex1-FM     | 4000  | <u>3390</u> |
| 837980   | RFC 400-10/2,2-3-L-AKV2            | 7200  | <u>2205</u> |
| 837988   | RFC 400-10/1,9-3-L-AKV2-Ex1        | 7000  | <u>2946</u> |
| 838004   | RFC 400-10/2,2-3-L-AKV2-Ex1-FM     | 7200  | <u>3551</u> |
| 832835   | RFC 400-15A/4-3-L-AKV2             | 7200  | <u>2247</u> |
| 832840   | RFC 400-15A/3,6-3-L-AKV2-Ex1       | 6800  | <u>3001</u> |
| 838018   | RFC 400-15A/4-3-L-AKV2-Ex1-FM      | 7200  | <u>3574</u> |
| 832833   | RFC 400-15/4-3-L-AKV2              | 7200  | <u>2247</u> |
| 832839   | RFC 400-15/3,6-3-L-AKV2-Ex1        | 6800  | <u>3001</u> |
| 838032   | RFC 400-15/4-3-L-AKV2-Ex1-FM       | 7200  | <u>3574</u> |
| 836408   | RFC 400-15/5,5-3-L-AKV2            | 8500  | <u>2388</u> |
| 842647   | RFC 400-15A/7,5-3-L-AKV2           | 13500 | <u>2481</u> |
| 842655   | RFC 400-15A/6,8-3-L-AKV2-Ex1       | 13500 | <u>3405</u> |
| 842671   | RFC 400-15A/7,5-3-L-AKV2-Ex1-FM    | 13500 | <u>4528</u> |
| 838390   | RFC 400-10/1,5-3-L-AKV2-H          | 6000  | <u>2473</u> |
| 832842   | RFC 400-10/1,3-3-L-AKV2-Ex1-H      | 4500  | <u>3215</u> |
| 838408   | RFC 400-10/1,5-3-L-AKV2-Ex1-FM-H   | 4500  | <u>3750</u> |
| 838416   | RFC 400-10/2,2-3-L-AKV2-H          | 7200  | <u>2565</u> |
| 838424   | RFC 400-10/1,9-3-L-AKV2-Ex1-H      | 7000  | <u>3342</u> |
| 838440   | RFC 400-10/2,2-3-L-AKV2-Ex1-FM-H   | 7200  | <u>3911</u> |
| 838448   | RFC 400-15A/4-3-L-AKV2-H           | 7200  | <u>2607</u> |
| 832846   | RFC 400-15A/3,6-3-L-AKV2-Ex1-H     | 7200  | <u>3397</u> |
| 838466   | RFC 400-15A/4-3-L-AKV2-Ex1-FM-H    | 6800  | <u>3935</u> |
| 838474   | RFC 400-15/4-3-L-AKV2-H            | 7200  | <u>2607</u> |
| 832844   | RFC 400-15/3,6-3-L-AKV2-Ex1-H      | 6800  | <u>3397</u> |
| 838492   | RFC 400-15/4-3-L-AKV2-Ex1-FM-H     | 7200  | <u>3935</u> |
| 838500   | RFC 400-15/5,5-3-L-AKV2-H          | 8500  | <u>2748</u> |
| 842684   | RFC 400-15A/7,5-3-L-AKV2-H         | 15000 | <u>2841</u> |

AKV2





|                                    |                                    |        |             |
|------------------------------------|------------------------------------|--------|-------------|
| 842692                             | RFC 400-15A/6,8-3-L-AKV2-Ex1-H     | 13500  | <u>3801</u> |
| 842708                             | RFC 400-15A/7,5-3-L-AKV2-Ex1-FM-H  | 13500  | 4889        |
| 847371                             | RFC 400-10/1,5-3-L-AKV2-HL         | 6000   | 2473        |
| 847356                             | RFC 400-10/1,3-3-L-AKV2-Ex1-HL     | 4500   | <u>3215</u> |
| 847363                             | RFC 400-10/1,2-3-L-AKV2-Ex2-FM-HL  | 4500   | 3191        |
| 847370                             | RFC 400-10/1,5-3-L-AKV2-Ex1-FM-HL  | 7000   | 3750        |
| 847397                             | RFC 400-10/2,2-3-L-AKV2-HL         | 7200   | 2565        |
| 847389                             | RFC 400-10/1,9-3-L-AKV2-Ex1-HL     | 7200   | <u>3342</u> |
| 847383                             | RFC 400-10/1,78-3-L-AKV2-Ex2-FM-HL | 7200   | 3314        |
| 847396                             | RFC 400-10/2,2-3-L-AKV2-Ex1-FM-HL  | 7200   | 3911        |
| 847445                             | RFC 400-15A/4-3-L-AKV2-HL          | 6800   | 2607        |
| 847360                             | RFC 400-15A/3,6-3-L-AKV2-Ex1-HL    | 7200   | <u>3397</u> |
| 847437                             | RFC 400-15A/3,3-3-L-AKV2-Ex2-FM-HL | 6800   | 3365        |
| 847444                             | RFC 400-15A/4-3-L-AKV2-Ex1-FM-HL   | 7200   | 3935        |
| 847417                             | RFC 400-15/4-3-L-AKV2-HL           | 8500   | 2607        |
| 847358                             | RFC 400-15/3,6-3-L-AKV2-Ex1-HL     | 7000   | <u>3397</u> |
| 847409                             | RFC 400-15/3,3-3-L-AKV2-Ex2-FM-HL  | 6800   | 3365        |
| 847416                             | RFC 400-15/4-3-L-AKV2-Ex1-FM-HL    | 7200   | 3935        |
| 847429                             | RFC 400-15/5,5-3-L-AKV2-HL         | 8000   | 2748        |
| 847474                             | RFC 400-15A/7,5-3-L-AKV2-HL        | 15500  | 2841        |
| 847460                             | RFC 400-15A/6,8-3-L-AKV2-Ex1-HL    | 15000  | <u>3801</u> |
| 847466                             | RFC 400-15A/6,0-3-L-AKV2-Ex2-FM-HL | 13500  | 3768        |
| 847480                             | RFC 400-15A/7,5-3-L-AKV2-Ex1-FM-HL | 15500  | 4889        |
| <b>RFC 500 - CINKUOTAS PLIENAS</b> |                                    |        |             |
| 831786                             | RFC 500-7A/3-3-L-Z                 | 12000  | 1623        |
| 838042                             | RFC 500-7A/3-3-L-Z-Ex1-FM          | 12000  | 3571        |
| 832853                             | RFC 500-7/4-3-L-Z                  | 15000  | 2059        |
| 830428                             | RFC 500-10A/5,5-3-L-Z              | 14500  | 1444        |
| 830789                             | RFC 500-10A/4,8-3-L-Z-Ex1          | 12500  | <u>2485</u> |
| 832967                             | RFC 500-10A/5,5-3-L-Z-Ex1-FM       | 14500  | 3431        |
| 23550                              | RFC 500-10/5,5-3-L-Z               | 11500  | 1444        |
| 23551                              | RFC 500-10/4,8-3-L-Z-Ex1           | 10500  | <u>2485</u> |
| 832965                             | RFC 500-10/5,5-3-L-Z-Ex1-FM        | 11500  | 3431        |
| 844247                             | RFC 500-10A/7,5-3-L-Z              | 16 000 | 1903        |
| 844255                             | RFC 500-10A/6,6-3-L-Z-Ex1          | 15 500 | <u>2885</u> |
| 844271                             | RFC 500-10A/7,5-3-L-Z-Ex1-FM       | 16 000 | 4119        |
| 844215                             | RFC 500-10/7,5-3-L-Z               | 16 000 | 1903        |
| 844223                             | RFC 500-10/6,6-3-L-Z-Ex1           | 15 500 | <u>2885</u> |
| 844239                             | RFC 500-10/7,5-3-L-Z-Ex1-FM        | 16 000 | 4119        |
| 838502                             | RFC 500-7A/3-3-L-Z-H               | 12000  | 1824        |
| 838518                             | RFC 500-7A/3-3-L-Z-Ex1-FM-H        | 12000  | 3771        |
| 838526                             | RFC 500-7/4-3-L-Z-H                | 15000  | 2259        |
| 838534                             | RFC 500-10A/5,5-3-L-Z-H            | 14500  | 1645        |
| 830094                             | RFC 500-10A/4,8-3-L-Z-Ex1-H        | 12500  | <u>2736</u> |
| 838552                             | RFC 500-10A/5,5-3-L-Z-Ex1-FM-H     | 14500  | 3631        |
| 838560                             | RFC 500-10/5,5-3-L-Z-H             | 11500  | 1645        |
| 830023                             | RFC 500-10/4,8-3-L-Z-Ex1-H         | 10500  | <u>2736</u> |
| 838578                             | RFC 500-10/5,5-3-L-Z-Ex1-FM-H      | 12000  | 3631        |
| 838586                             | RFC 500-10A/7,5-3-L-Z-H            | 17000  | 2104        |
| 838594                             | RFC 500-10A/6,6-3-L-Z-Ex1-H        | 13000  | <u>3135</u> |
| 838610                             | RFC 500-10A/7,5-3-L-Z-Ex1-FM-H     | 17000  | 4320        |
| 838618                             | RFC 500-10/7,5-3-L-Z-H             | 17000  | 2104        |
| 838626                             | RFC 500-10/6,6-3-L-Z-Ex1-H         | 15500  | <u>3135</u> |
| 838642                             | RFC 500-10/7,5-3-L-Z-Ex1-FM-H      | 17000  | 4320        |
| 847606                             | RFC 500-7A/3-3-L-Z-HL              | 12000  | 1824        |
| 847605                             | RFC 500-7A/3-3-L-Z-Ex1-FM-HL       | 12000  | 3771        |
| 847589                             | RFC 500-7/4-3-L-Z-HL               | 15000  | 2259        |
| 847552                             | RFC 500-10A/5,5-3-L-Z-HL           | 15000  | 1645        |

**RFC-500**

|   |                                    |        |             |
|---|------------------------------------|--------|-------------|
| 847484  | RFC 500-10A/4,8-3-L-Z-Ex1-HL       | 12500  | <u>2736</u> |
| 847551  | RFC 500-10A/5,5-3-L-Z-Ex1-FM-HL    | 14500  | <u>3631</u> |
| 847506  | RFC 500-10/5,5-3-L-Z-HL            | 14500  | <u>1645</u> |
| 847482  | RFC 500-10/4,8-3-L-Z-Ex1-HL        | 14000  | <u>2736</u> |
| 847505  | RFC 500-10/5,5-3-L-Z-Ex1-FM-HL     | 14500  | <u>3631</u> |
| 847578  | RFC 500-10A/7,5-3-L-Z-HL           | 16500  | <u>2104</u> |
| 847568  | RFC 500-10A/6,6-3-L-Z-Ex1-HL       | 15500  | <u>3135</u> |
| 847577  | RFC 500-10A/7,5-3-L-Z-Ex1-FM-HL    | 17000  | <u>4320</u> |
| 847532  | RFC 500-10/7,5-3-L-Z-HL            | 17000  | <u>2104</u> |
| 847522  | RFC 500-10/6,6-3-L-Z-Ex1-HL        | 15500  | <u>3135</u> |
| 847531  | RFC 500-10/7,5-3-L-Z-Ex1-FM-HL     | 17000  | <u>4320</u> |
| <b><i>Nerūdijantis plienas - EN 10088/1-3-95 (AISI 304) maisto, farmācijas pramonei</i></b> |                                    |        |             |
| 832422  | RFC 500-7A/3-3-L-AKV1              | 12000  | <u>3182</u> |
| 838046  | RFC 500-7A/3-3-L-AKV1-Ex1-FM       | 12000  | <u>5291</u> |
| 831190  | RFC 500-7/4-3-L-AKV1               | 15000  | <u>3617</u> |
| 832428  | RFC 500-10A/5,5-3-L-AKV1           | 14500  | <u>3003</u> |
| 832433  | RFC 500-10A/4,8-3-L-AKV1-Ex1       | 12500  | <u>4265</u> |
| 838060  | RFC 500-10A/5,5-3-L-AKV1-Ex1-FM    | 14500  | <u>5151</u> |
| 831193  | RFC 500-10/5,5-3-L-AKV1            | 11500  | <u>3003</u> |
| 831194  | RFC 500-10/4,8-3-L-AKV1-Ex1        | 10500  | <u>4265</u> |
| 838074  | RFC 500-10/5,5-3-L-AKV1-Ex1-FM     | 11500  | <u>5151</u> |
| 844251  | RFC 500-10A/7,5-3-L-AKV1           | 16 000 | <u>3462</u> |
| 844259  | RFC 500-10A/6,6-3-L-AKV1-Ex1       | 15 500 | <u>4632</u> |
| 844275  | RFC 500-10A/7,5-3-L-AKV1-Ex1-FM    | 16 000 | <u>5840</u> |
| 844219  | RFC 500-10/7,5-3-L-AKV1            | 16 000 | <u>3462</u> |
| 844227  | RFC 500-10/6,6-3-L-AKV1-Ex1        | 15 500 | <u>4632</u> |
| 844243  | RFC 500-10/7,5-3-L-AKV1-Ex1-FM     | 16 000 | <u>5840</u> |
| 838506  | RFC 500-7A/3-3-L-AKV1-H            | 12000  | <u>3848</u> |
| 838522  | RFC 500-7A/3-3-L-AKV1-Ex1-FM-H     | 12000  | <u>5957</u> |
| 838530  | RFC 500-7/4-3-L-AKV1-H             | 15000  | <u>4283</u> |
| 838538  | RFC 500-10A/5,5-3-L-AKV1-H         | 14500  | <u>3669</u> |
| 831117  | RFC 500-10A/4,8-3-L-AKV1-Ex1-H     | 12500  | <u>5031</u> |
| 838556  | RFC 500-10A/5,5-3-L-AKV1-Ex1-FM-H  | 14500  | <u>5817</u> |
| 838564  | RFC 500-10/5,5-3-L-AKV1-H          | 11500  | <u>3669</u> |
| 831115  | RFC 500-10/4,8-3-L-AKV1-Ex1-H      | 10500  | <u>5031</u> |
| 838582  | RFC 500-10/5,5-3-L-AKV1-Ex1-FM-H   | 12000  | <u>5817</u> |
| 838590  | RFC 500-10A/7,5-3-L-AKV1-H         | 17000  | <u>4128</u> |
| 838598  | RFC 500-10A/6,6-3-L-AKV1-Ex1-H     | 13000  | <u>5398</u> |
| 838614  | RFC 500-10A/7,5-3-L-AKV1-Ex1-FM-H  | 17000  | <u>6506</u> |
| 838622  | RFC 500-10/7,5-3-L-AKV1-H          | 17000  | <u>4128</u> |
| 838630  | RFC 500-10/6,6-3-L-AKV1-Ex1-H      | 15500  | <u>5398</u> |
| 838646  | RFC 500-10/7,5-3-L-AKV1-Ex1-FM-H   | 17000  | <u>6506</u> |
| 847601  | RFC 500-7A/3-3-L-AKV1-HL           | 12000  | <u>3848</u> |
| 847600  | RFC 500-7A/3-3-L-AKV1-Ex1-FM-HL    | 12000  | <u>5957</u> |
| 847586  | RFC 500-7/4-3-L-AKV1-HL            | 15000  | <u>4283</u> |
| 847547  | RFC 500-10A/5,5-3-L-AKV1-HL        | 15000  | <u>3669</u> |
| 847488  | RFC 500-10A/4,8-3-L-AKV1-Ex1-HL    | 12500  | <u>5031</u> |
| 847546  | RFC 500-10A/5,5-3-L-AKV1-Ex1-FM-HL | 14500  | <u>5817</u> |
| 847501  | RFC 500-10/5,5-3-L-AKV1-HL         | 14500  | <u>3669</u> |
| 847486  | RFC 500-10/4,8-3-L-AKV1-Ex1-HL     | 14000  | <u>5031</u> |
| 847500  | RFC 500-10/5,5-3-L-AKV1-Ex1-FM-HL  | 14500  | <u>5817</u> |
| 847573  | RFC 500-10A/7,5-3-L-AKV1-HL        | 16500  | <u>4128</u> |
| 847566  | RFC 500-10A/6,6-3-L-AKV1-Ex1-HL    | 15500  | <u>5398</u> |
| 847572  | RFC 500-10A/7,5-3-L-AKV1-Ex1-FM-HL | 17000  | <u>6506</u> |
| 847527  | RFC 500-10/7,5-3-L-AKV1-HL         | 17000  | <u>4128</u> |
| 847520  | RFC 500-10/6,6-3-L-AKV1-Ex1-HL     | 15500  | <u>5398</u> |
| 847526  | RFC 500-10/7,5-3-L-AKV1-Ex1-FM-HL  | 17000  | <u>6506</u> |

AKV1



AKV2

| <b>Nerūdijantis plienas - EN 10088-95 (AISI 316) chemijos pramonei</b> |                                    |        |      |
|--|------------------------------------|--------|------|
| 832861   | RFC 500-7A/3-3-L-AKV2              | 12000  | 3456 |
| 838048   | RFC 500-7A/3-3-L-AKV2-Ex1-FM       | 12000  | 5606 |
| 832859   | RFC 500-7/4-3-L-AKV2               | 15000  | 3891 |
| 831801   | RFC 500-10A/5,5-3-L-AKV2           | 14500  | 3277 |
| 832869   | RFC 500-10A/4,8-3-L-AKV2-Ex1       | 12500  | 4506 |
| 838062   | RFC 500-10A/5,5-3-L-AKV2-Ex1-FM    | 14500  | 5466 |
| 832863   | RFC 500-10/5,5-3-L-AKV2            | 11500  | 3277 |
| 832865   | RFC 500-10/4,8-3-L-AKV2-Ex1        | 10500  | 4506 |
| 838076   | RFC 500-10/5,5-3-L-AKV2-Ex1-FM     | 11500  | 5466 |
| 844253   | RFC 500-10A/7,5-3-L-AKV2           | 16 000 | 3736 |
| 844261   | RFC 500-10A/6,6-3-L-AKV2-Ex1       | 15 500 | 4864 |
| 844277   | RFC 500-10A/7,5-3-L-AKV2-Ex1-FM    | 16 000 | 6154 |
| 844221   | RFC 500-10/7,5-3-L-AKV2            | 16 000 | 3736 |
| 844229   | RFC 500-10/6,6-3-L-AKV2-Ex1        | 15 500 | 4864 |
| 844245   | RFC 500-10/7,5-3-L-AKV2-Ex1-FM     | 16 000 | 6154 |
| 838508   | RFC 500-7A/3-3-L-AKV2-H            | 12000  | 4202 |
| 838524   | RFC 500-7A/3-3-L-AKV2-Ex1-FM-H     | 12000  | 6352 |
| 838532   | RFC 500-7/4-3-L-AKV2-H             | 15000  | 4637 |
| 838540   | RFC 500-10A/5,5-3-L-AKV2-H         | 14500  | 4023 |
| 832873   | RFC 500-10A/4,8-3-L-AKV2-Ex1-H     | 12500  | 5341 |
| 838558   | RFC 500-10A/5,5-3-L-AKV2-Ex1-FM-H  | 14500  | 6212 |
| 838566   | RFC 500-10/5,5-3-L-AKV2-H          | 11500  | 4023 |
| 832871   | RFC 500-10/4,8-3-L-AKV2-Ex1-H      | 10500  | 5341 |
| 838584   | RFC 500-10/5,5-3-L-AKV2-Ex1-FM-H   | 12000  | 6212 |
| 838592   | RFC 500-10A/7,5-3-L-AKV2-H         | 17000  | 4482 |
| 838600   | RFC 500-10A/6,6-3-L-AKV2-Ex1-H     | 13000  | 5699 |
| 838616   | RFC 500-10A/7,5-3-L-AKV2-Ex1-FM-H  | 17000  | 6901 |
| 838624   | RFC 500-10/7,5-3-L-AKV2-H          | 17000  | 4482 |
| 838632   | RFC 500-10/6,6-3-L-AKV2-Ex1-H      | 15500  | 5699 |
| 838648   | RFC 500-10/7,5-3-L-AKV2-Ex1-FM-H   | 17000  | 6901 |
| 847603   | RFC 500-7A/3-3-L-AKV2-HL           | 12000  | 4202 |
| 847602   | RFC 500-7A/3-3-L-AKV2-Ex1-FM-HL    | 12000  | 6352 |
| 847587   | RFC 500-7/4-3-L-AKV2-HL            | 15000  | 4637 |
| 847549   | RFC 500-10A/5,5-3-L-AKV2-HL        | 15000  | 4023 |
| 847492   | RFC 500-10A/4,8-3-L-AKV2-Ex1-HL    | 12500  | 5341 |
| 847548   | RFC 500-10A/5,5-3-L-AKV2-Ex1-FM-HL | 14500  | 6212 |
| 847503   | RFC 500-10/5,5-3-L-AKV2-HL         | 14500  | 4023 |
| 847490   | RFC 500-10/4,8-3-L-AKV2-Ex1-HL     | 14000  | 5341 |
| 847502   | RFC 500-10/5,5-3-L-AKV2-Ex1-FM-HL  | 14500  | 6212 |
| 847575   | RFC 500-10A/7,5-3-L-AKV2-HL        | 16500  | 4482 |
| 847567   | RFC 500-10A/6,6-3-L-AKV2-Ex1-HL    | 15500  | 5699 |
| 847574   | RFC 500-10A/7,5-3-L-AKV2-Ex1-FM-HL | 17000  | 6901 |
| 847529   | RFC 500-10/7,5-3-L-AKV2-HL         | 17000  | 4482 |
| 847521   | RFC 500-10/6,6-3-L-AKV2-Ex1-HL     | 15500  | 5699 |
| 847528   | RFC 500-10/7,5-3-L-AKV2-Ex1-FM-HL  | 17000  | 6901 |



RFC-630

| <b>RFC 630 - CINKUOTAS PLIENAS</b> |                              |       |      |
|------------------------------------|------------------------------|-------|------|
| 842100                             | RFC 630-7A/11-3-L-Z          | 25000 | 3661 |
| 842132                             | RFC 630-7A/11-3-L-Z-Ex1-FM   | 25000 | 6685 |
| 842092                             | RFC 630-7/11-3-L-Z           | 25000 | 3661 |
| 842124                             | RFC 630-7/11-3-L-Z-Ex1-FM    | 25000 | 6685 |
| 842148                             | RFC 630-10A/7,5-3-L-Z        | 12500 | 2243 |
| 842164                             | RFC 630-10A/6,6-3-L-Z-Ex1    | 12500 | 3257 |
| 842196                             | RFC 630-10A/7,5-3-L-Z-Ex1-FM | 12500 | 4553 |
| 842140                             | RFC 630-10/7,5-3-L-Z         | 12500 | 2243 |
| 842156                             | RFC 630-10/6,6-3-L-Z-Ex1     | 12500 | 3257 |
| 842188                             | RFC 630-10/7,5-3-L-Z-Ex1-FM  | 12500 | 4553 |
| 842212                             | RFC 630-10A/11-3-L-Z         | 18000 | 2307 |



|  |                                 |       |             |
|--|---------------------------------|-------|-------------|
| 842228   | RFC 630-10A/9,7-3-L-Z-Ex1       | 14000 | <u>3842</u> |
| 842260   | RFC 630-10A/11-3-L-Z-Ex1-FM     | 12500 | 4893        |
| 842204   | RFC 630-10/11-3-L-Z             | 18000 | 2307        |
| 842220   | RFC 630-10/9,7-3-L-Z-Ex1        | 13500 | <u>3842</u> |
| 842252   | RFC 630-10/11-3-L-Z-Ex1-FM      | 12500 | 4893        |
| 842345   | RFC 630-7A/11-3-L-Z-H           | 25000 | 3967        |
| 842377   | RFC 630-7A/11-3-L-Z-Ex1-FM-H    | 22500 | 6992        |
| 842337   | RFC 630-7/11-3-L-Z-H            | 25000 | 3967        |
| 842369   | RFC 630-7/11-3-L-Z-Ex1-FM-H     | 22500 | 6992        |
| 842393   | RFC 630-10A/7,5-3-L-Z-H         | 12500 | 2550        |
| 842409   | RFC 630-10A/6,6-3-L-Z-Ex1-H     | 10500 | <u>3625</u> |
| 842441   | RFC 630-10A/7,5-3-L-Z-Ex1-FM-H  | 12500 | 4859        |
| 842385   | RFC 630-10/7,5-3-L-Z-H          | 12500 | 2550        |
| 842401   | RFC 630-10/6,6-3-L-Z-Ex1-H      | 12500 | <u>3625</u> |
| 842433   | RFC 630-10/7,5-3-L-Z-Ex1-FM-H   | 12500 | 4859        |
| 842457   | RFC 630-10A/11-3-L-Z-H          | 18000 | 2614        |
| 842473   | RFC 630-10A/9,7-3-L-Z-Ex1-H     | 12500 | <u>4210</u> |
| 842505   | RFC 630-10A/11-3-L-Z-Ex1-FM-H   | 14500 | 5199        |
| 842449   | RFC 630-10/11-3-L-Z-H           | 18000 | 2614        |
| 842465   | RFC 630-10/9,7-3-L-Z-Ex1-H      | 14500 | <u>4210</u> |
| 842497   | RFC 630-10/11-3-L-Z-Ex1-FM-H    | 12500 | 5199        |
| 847662   | RFC 630-7A/11-3-L-Z-HL          | 18000 | 3967        |
| 847676   | RFC 630-7A/11-3-L-Z-Ex1-FM-HL   | 21000 | 6992        |
| 847654   | RFC 630-7/11-3-L-Z-HL           | 25000 | 3967        |
| 847670   | RFC 630-7/11-3-L-Z-Ex1-FM-HL    | 21000 | 6992        |
| 847690   | RFC 630-10A/7,5-3-L-Z-HL        | 12500 | 2550        |
| 847716   | RFC 630-10A/6,6-3-L-Z-Ex1-HL    | 10500 | <u>3625</u> |
| 847704   | RFC 630-10A/7,5-3-L-Z-Ex1-FM-HL | 10500 | 4859        |
| 847682   | RFC 630-10/7,5-3-L-Z-HL         | 12500 | 2550        |
| 847710   | RFC 630-10/6,6-3-L-Z-Ex1-HL     | 10500 | <u>3625</u> |
| 847698   | RFC 630-10/7,5-3-L-Z-Ex1-FM-HL  | 12500 | 4859        |
| 847622   | RFC 630-10A/11-3-L-Z-HL         | 18000 | 2614        |
| 847648   | RFC 630-10A/9,7-3-L-Z-Ex1-HL    | 13500 | <u>4210</u> |
| 847636   | RFC 630-10A/11-3-L-Z-Ex1-FM-HL  | 12500 | 5199        |
| 847614   | RFC 630-10/11-3-L-Z-HL          | 18000 | 2614        |
| 847642   | RFC 630-10/9,7-3-L-Z-Ex1-HL     | 12500 | <u>4210</u> |
| 847630   | RFC 630-10/11-3-L-Z-Ex1-FM-HL   | 12500 | 5199        |
| <b>Nerūdijantis plienas - EN 10088/1-3-95 (AISI 304) maisto, farmācijas pramonei</b> |                                 |       |             |
| 842104   | RFC 630-7A/11-3-L-AKV1          | 25000 | 6028        |
| 842136   | RFC 630-7A/11-3-L-AKV1-Ex1-FM   | 25000 | 9237        |
| 842096   | RFC 630-7/11-3-L-AKV1           | 25000 | 6028        |
| 842128   | RFC 630-7/11-3-L-AKV1-Ex1-FM    | 25000 | 9237        |
| 842152   | RFC 630-10A/7,5-3-L-AKV1        | 12500 | 4610        |
| 842168   | RFC 630-10A/6,6-3-L-AKV1-Ex1    | 12500 | <u>6320</u> |
| 842200   | RFC 630-10A/7,5-3-L-AKV1-Ex1-FM | 12500 | 7105        |
| 842144   | RFC 630-10/7,5-3-L-AKV1         | 12500 | 4610        |
| 842160   | RFC 630-10/6,6-3-L-AKV1-Ex1     | 12500 | <u>6320</u> |
| 842192   | RFC 630-10/7,5-3-L-AKV1-Ex1-FM  | 12500 | 7105        |
| 842216   | RFC 630-10A/11-3-L-AKV1         | 18000 | 4674        |
| 842232   | RFC 630-10A/9,7-3-L-AKV1-Ex1    | 14000 | <u>6905</u> |
| 842264   | RFC 630-10A/11-3-L-AKV1-Ex1-FM  | 12500 | 7445        |
| 842208   | RFC 630-10/11-3-L-AKV1          | 18000 | 4674        |
| 842224   | RFC 630-10/9,7-3-L-AKV1-Ex1     | 13500 | <u>6905</u> |
| 842256   | RFC 630-10/11-3-L-AKV1-Ex1-FM   | 12500 | 7445        |
| 842349   | RFC 630-7A/11-3-L-AKV1-H        | 25000 | 7046        |
| 842381   | RFC 630-7A/11-3-L-AKV1-Ex1-FM-H | 22500 | 10256       |
| 842341   | RFC 630-7/11-3-L-AKV1-H         | 25000 | 7046        |
| 842373   | RFC 630-7/11-3-L-AKV1-Ex1-FM-H  | 22500 | 10256       |

AKV1



|  |                                    |       |       |
|--|------------------------------------|-------|-------|
| 842397   | RFC 630-10A/7,5-3-L-AKV1-H         | 12500 | 5628  |
| 842413   | RFC 630-10A/6,6-3-L-AKV1-Ex1-H     | 10500 | 7542  |
| 842445   | RFC 630-10A/7,5-3-L-AKV1-Ex1-FM-H  | 12500 | 8123  |
| 842389   | RFC 630-10/7,5-3-L-AKV1-H          | 12500 | 5628  |
| 842405   | RFC 630-10/6,6-3-L-AKV1-Ex1-H      | 12500 | 7542  |
| 842437   | RFC 630-10/7,5-3-L-AKV1-Ex1-FM-H   | 12500 | 8123  |
| 842461   | RFC 630-10A/11-3-L-AKV1-H          | 18000 | 5692  |
| 842477   | RFC 630-10A/9,7-3-L-AKV1-Ex1-H     | 12500 | 8126  |
| 842509   | RFC 630-10A/11-3-L-AKV1-Ex1-FM-H   | 14500 | 8463  |
| 842453   | RFC 630-10/11-3-L-AKV1-H           | 18000 | 5692  |
| 842469   | RFC 630-10/9,7-3-L-AKV1-Ex1-H      | 14500 | 8126  |
| 842501   | RFC 630-10/11-3-L-AKV1-Ex1-FM-H    | 12500 | 8463  |
| 847666   | RFC 630-7A/11-3-L-AKV1-HL          | 18000 | 7046  |
| 847678   | RFC 630-7A/11-3-L-AKV1-Ex1-FM-HL   | 21000 | 10256 |
| 847658   | RFC 630-7/11-3-L-AKV1-HL           | 25000 | 7046  |
| 847672   | RFC 630-7/11-3-L-AKV1-Ex1-FM-HL    | 21000 | 10256 |
| 847694   | RFC 630-10A/7,5-3-L-AKV1-HL        | 12500 | 5628  |
| 847718   | RFC 630-10A/6,6-3-L-AKV1-Ex1-HL    | 10500 | 7542  |
| 847706   | RFC 630-10A/7,5-3-L-AKV1-Ex1-FM-HL | 10500 | 8123  |
| 847686   | RFC 630-10/7,5-3-L-AKV1-HL         | 12500 | 5628  |
| 847712   | RFC 630-10/6,6-3-L-AKV1-Ex1-HL     | 10500 | 7542  |
| 847700   | RFC 630-10/7,5-3-L-AKV1-Ex1-FM-HL  | 12500 | 8123  |
| 847626   | RFC 630-10A/11-3-L-AKV1-HL         | 18000 | 5692  |
| 847650   | RFC 630-10A/9,7-3-L-AKV1-Ex1-HL    | 13500 | 8126  |
| 847638   | RFC 630-10A/11-3-L-AKV1-Ex1-FM-HL  | 12500 | 8463  |
| 847618   | RFC 630-10/11-3-L-AKV1-HL          | 18000 | 5692  |
| 847644   | RFC 630-10/9,7-3-L-AKV1-Ex1-HL     | 12500 | 8126  |
| 847632   | RFC 630-10/11-3-L-AKV1-Ex1-FM-HL   | 12500 | 8463  |
| <b>Nerūdijantis plienas - EN 10088-95 (AISI 316) chemijos pramonei</b> |                                    |       |       |
| 842106   | RFC 630-7A/11-3-L-AKV2             | 25000 | 6434  |
| 842138   | RFC 630-7A/11-3-L-AKV2-Ex1-FM      | 25000 | 9697  |
| 842098   | RFC 630-7/11-3-L-AKV2              | 25000 | 6434  |
| 842130   | RFC 630-7/11-3-L-AKV2-Ex1-FM       | 25000 | 9697  |
| 842154   | RFC 630-10A/7,5-3-L-AKV2           | 12500 | 5016  |
| 842170   | RFC 630-10A/6,6-3-L-AKV2-Ex1       | 12500 | 6584  |
| 842202   | RFC 630-10A/7,5-3-L-AKV2-Ex1-FM    | 12500 | 7564  |
| 842146   | RFC 630-10/7,5-3-L-AKV2            | 12500 | 5016  |
| 842162   | RFC 630-10/6,6-3-L-AKV2-Ex1        | 12500 | 6584  |
| 842194   | RFC 630-10/7,5-3-L-AKV2-Ex1-FM     | 12500 | 7564  |
| 842218   | RFC 630-10A/11-3-L-AKV2            | 18000 | 5081  |
| 842234   | RFC 630-10A/9,7-3-L-AKV2-Ex1       | 14000 | 7145  |
| 842266   | RFC 630-10A/11-3-L-AKV2-Ex1-FM     | 12500 | 7904  |
| 842210   | RFC 630-10/11-3-L-AKV2             | 18000 | 5081  |
| 842226   | RFC 630-10/9,7-3-L-AKV2-Ex1        | 13500 | 7145  |
| 842258   | RFC 630-10/11-3-L-AKV2-Ex1-FM      | 12500 | 7904  |
| 842351   | RFC 630-7A/11-3-L-AKV2-H           | 25000 | 7574  |
| 842383   | RFC 630-7A/11-3-L-AKV2-Ex1-FM-H    | 22500 | 10837 |
| 842343   | RFC 630-7/11-3-L-AKV2-H            | 25000 | 7574  |
| 842375   | RFC 630-7/11-3-L-AKV2-Ex1-FM-H     | 22500 | 10837 |
| 842399   | RFC 630-10A/7,5-3-L-AKV2-H         | 12500 | 6157  |
| 842415   | RFC 630-10A/6,6-3-L-AKV2-Ex1-H     | 10500 | 7899  |
| 842447   | RFC 630-10A/7,5-3-L-AKV2-Ex1-FM-H  | 12500 | 8704  |
| 842391   | RFC 630-10/7,5-3-L-AKV2-H          | 12500 | 6157  |
| 842407   | RFC 630-10/6,6-3-L-AKV2-Ex1-H      | 12500 | 7899  |
| 842439   | RFC 630-10/7,5-3-L-AKV2-Ex1-FM-H   | 12500 | 8704  |
| 842463   | RFC 630-10A/11-3-L-AKV2-H          | 18000 | 6221  |
| 842479   | RFC 630-10A/9,7-3-L-AKV2-Ex1-H     | 12500 | 8456  |
| 842511   | RFC 630-10A/11-3-L-AKV2-Ex1-FM-H   | 14500 | 9045  |

AKV2



|        |                                    |       |       |
|--------|------------------------------------|-------|-------|
| 842455 | RFC 630-10/11-3-L-AKV2-H           | 18000 | 6221  |
| 842471 | RFC 630-10/9,7-3-L-AKV2-Ex1-H      | 14500 | 8456  |
| 842503 | RFC 630-10/11-3-L-AKV2-Ex1-FM-H    | 12500 | 9045  |
| 847668 | RFC 630-7A/11-3-L-AKV2-HL          | 18000 | 7574  |
| 847680 | RFC 630-7A/11-3-L-AKV2-Ex1-FM-HL   | 21000 | 10837 |
| 847660 | RFC 630-7/11-3-L-AKV2-HL           | 25000 | 7574  |
| 847674 | RFC 630-7/11-3-L-AKV2-Ex1-FM-HL    | 21000 | 10837 |
| 847696 | RFC 630-10A/7,5-3-L-AKV2-HL        | 12500 | 6157  |
| 847720 | RFC 630-10A/6,6-3-L-AKV2-Ex1-HL    | 10500 | 7899  |
| 847708 | RFC 630-10A/7,5-3-L-AKV2-Ex1-FM-HL | 10500 | 8704  |
| 847688 | RFC 630-10/7,5-3-L-AKV2-HL         | 12500 | 6157  |
| 847714 | RFC 630-10/6,6-3-L-AKV2-Ex1-HL     | 10500 | 7899  |
| 847702 | RFC 630-10/7,5-3-L-AKV2-Ex1-FM-HL  | 12500 | 8704  |
| 847628 | RFC 630-10A/11-3-L-AKV2-HL         | 18000 | 6221  |
| 847652 | RFC 630-10A/9,7-3-L-AKV2-Ex1-HL    | 13500 | 8456  |
| 847640 | RFC 630-10A/11-3-L-AKV2-Ex1-FM-HL  | 12500 | 9045  |
| 847620 | RFC 630-10/11-3-L-AKV2-HL          | 18000 | 6221  |
| 847646 | RFC 630-10/9,7-3-L-AKV2-Ex1-HL     | 12500 | 8456  |
| 847634 | RFC 630-10/11-3-L-AKV2-Ex1-FM-HL   | 12500 | 9045  |



### **RADIALINIAI VENTILIATORIAI RFE -**

#### ***Vidutinio slėgio, atgal lenktomis mentelėmis***

| Kodas                              | Žymėjimas                | V max. m <sup>3</sup> /h | Kaina EUR be PVM |
|------------------------------------|--------------------------|--------------------------|------------------|
| <b>RFE-200</b>                     |                          |                          |                  |
| <b>RFE 200 - CINKUOTAS PLIENAS</b> |                          |                          |                  |
| 26110                              | RFE 200-30/0,25-3-L-Z    | 1100                     | 327              |
| 839362                             | RFE 200-30/0,25-3-L-Z-H  | 1100                     | 350              |
| 847758                             | RFE 200-30/0,25-3-L-Z-HL | 1100                     | 350              |
| <b>RFE-250</b>                     |                          |                          |                  |
| <b>RFE 250 - CINKUOTAS PLIENAS</b> |                          |                          |                  |
| 27210                              | RFE 250-30/0,37-3-L-Z    | 2200                     | 394              |
| 839366                             | RFE 250-30/0,37-3-L-Z-H  | 2200                     | 424              |
| 847762                             | RFE 250-30/0,37-3-L-Z-HL | 2200                     | 424              |
| <b>RFE-280</b>                     |                          |                          |                  |
| <b>RFE 280 - CINKUOTAS PLIENAS</b> |                          |                          |                  |
| 27550                              | RFE 280-30/0,75-3-L-Z    | 3400                     | 479              |
| 839370                             | RFE 280-30/0,75-3-L-Z-H  | 3400                     | 523              |
| 847766                             | RFE 280-30/0,75-3-L-Z-HL | 3400                     | 523              |
| <b>RFE-315</b>                     |                          |                          |                  |
| <b>RFE 315 - CINKUOTAS PLIENAS</b> |                          |                          |                  |
| 28210                              | RFE 315-30/1,1-3-L-Z     | 4600                     | 569              |
| 839374                             | RFE 315-30/1,1-3-L-Z-H   | 4600                     | 636              |
| 847770                             | RFE 315-30/1,1-3-L-Z-HL  | 4600                     | 636              |
| Kodas                              | Žymėjimas                | V max. m <sup>3</sup> /h | Kaina EUR be PVM |
| <b>RFE-355</b>                     |                          |                          |                  |
| <b>RFE 355 - CINKUOTAS PLIENAS</b> |                          |                          |                  |
| 29550                              | RFE 355-30/2,2-3-L-Z     | 6400                     | 675              |
| 839378                             | RFE 355-30/2,2-3-L-Z-H   | 6400                     | 752              |
| 847774                             | RFE 355-30/2,2-3-L-Z-HL  | 6400                     | 752              |
| <b>RFE-400</b>                     |                          |                          |                  |
| <b>RFE 400 - CINKUOTAS PLIENAS</b> |                          |                          |                  |
| 29210                              | RFE 400-15/0,55-3-L-Z    | 4600                     | 674              |
| 839382                             | RFE 400-15/0,55-3-L-Z-H  | 4600                     | 767              |
| 847778                             | RFE 400-15/0,55-3-L-Z-HL | 4600                     | 767              |



| <b>Apsauginės grotelės įsiurbimo angai</b> |                     |    |
|--|---------------------|----|
| 835541                                     | RFC-RFE 200 MS-Z    | 13 |
| 835569                                     | RFC-RFE 200-MS-AKV1 | 45 |
| 835576                                     | RFC-RFE 200-MS-AKV2 | 50 |
| 835542                                     | RFC-RFE 250-MS-Z    | 18 |
| 835570                                     | RFC-RFE 250-MS-AKV1 | 61 |
| 835577                                     | RFC-RFE 250-MS-AKV2 | 68 |

|                                     |                       |     |
|-------------------------------------|-----------------------|-----|
| 835543                              | RFC-RFE 280-MS-Z      | 24  |
| 835571                              | RFC-RFE 280-MS-AKV1   | 80  |
| 835578                              | RFC-RFE 280-MS-AKV2   | 89  |
| 835544                              | RFC-RFE 315-MS-Z      | 25  |
| 835572                              | RFC-RFE 315-MS-AKV1   | 83  |
| 835579                              | RFC-RFE 315-MS-AKV2   | 93  |
| 835545                              | RFC-RFE 355-MS-Z      | 27  |
| 835573                              | RFC-RFE 355-MS-AKV1   | 91  |
| 835580                              | RFC-RFE 355-MS-AKV2   | 102 |
| 835546                              | RFC-RFE 400-MS-Z      | 38  |
| 835574                              | RFC-RFE 400-MS-AKV1   | 126 |
| 835581                              | RFC-RFE 400-MS-AKV2   | 141 |
| 835547                              | RFC-RFE 500-MS-Z      | 52  |
| 835575                              | RFC-RFE 500-MS-AKV1   | 172 |
| 835582                              | RFC-RFE 500-MS-AKV2   | 192 |
| 842301                              | RFC-RFE 630-MS-Z      | 73  |
| 842303                              | RFC-RFE 630-MS-AKV1   | 244 |
| 842304                              | RFC-RFE 630-MS-AKV2   | 273 |
| <b>Variklio apsauga nuo lietaus</b> |                       |     |
| 25031                               | RFC-RFE 200-KM-Z      | 14  |
| 25331                               | RFC-RFE 200-KM-AKV1   | 47  |
| 832752                              | RFC-RFE 200-KM-AKV2   | 52  |
| 835863                              | RFC-RFE 200-KM-A-Z    | 19  |
| 839426                              | RFC-RFE 200-KM-A-AKV1 | 64  |
| 839427                              | RFC-RFE 200-KM-A-AKV2 | 72  |
| 25032                               | RFC-RFE 250-KM-Z      | 18  |
| 25332                               | RFC-RFE 250-KM-AKV1   | 59  |
| 832765                              | RFC-RFE 250-KM-AKV2   | 66  |
| 833676                              | RFC-RFE 250-KM-A-Z    | 23  |
| 839429                              | RFC-RFE 250-KM-A-AKV1 | 76  |
| 833871                              | RFC-RFE 250-KM-A-AKV2 | 85  |
| 25232                               | RFC-PR 250-KM-Z       | 18  |
| 25132                               | RFC-RFE 280-KM-Z      | 21  |
| 25134                               | RFC-RFE 280-KM-AKV1   | 70  |
| 832777                              | RFC-RFE 280-KM-AKV2   | 78  |
| 833727                              | RFC-RFE 280-KM-A-Z    | 24  |
| 839431                              | RFC-RFE 280-KM-A-AKV1 | 80  |
| 833730                              | RFC-RFE 280-KM-A-AKV2 | 89  |
| 25033                               | RFC-RFE 315-KM-Z      | 25  |
| 25333                               | RFC-RFE 315-KM-AKV1   | 84  |
| 832005                              | RFC-RFE 315-KM-AKV2   | 94  |
| 833795                              | RFC-RFE 315-KM-A-Z    | 33  |
| 839432                              | RFC-RFE 315-KM-A-AKV1 | 110 |
| 839433                              | RFC-RFE 315-KM-A-AKV2 | 123 |
| 25233                               | RFC-PR 315-KM-Z       | 26  |
| 832917                              | RFC-RFE 355-KM-Z      | 31  |
| 832919                              | RFC-RFE 355-KM-AKV1   | 102 |
| 832823                              | RFC-RFE 355-KM-AKV2   | 114 |
| 833875                              | RFC-RFE 355-KM-A-Z    | 40  |
| 833879                              | RFC-RFE 355-KM-A-AKV1 | 132 |
| 837405                              | RFC-RFE 355-KM-A-AKV2 | 148 |
| 25034                               | RFC-RFE 400-KM-Z      | 35  |
| 25334                               | RFC-RFE 400-KM-AKV1   | 117 |
| 832849                              | RFC-RFE 400-KM-AKV2   | 131 |
| 833731                              | RFC-RFE 400-KM-A-Z    | 46  |
| 839436                              | RFC-RFE 400-KM-A-AKV1 | 153 |
| 833734                              | RFC-RFE 400-KM-A-AKV2 | 172 |
| 25234                               | RFC-PR 400-KM-Z       | 36  |

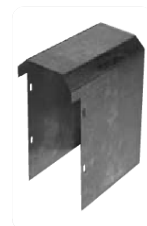
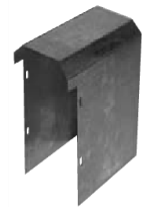

|   |                       |     |
|---|-----------------------|-----|
| 25035   | RFC-RFE 500-KM-Z      | 51  |
| 831962  | RFC-RFE 500-KM-AKV1   | 170 |
| 832875  | RFC-RFE 500-KM-AKV2   | 190 |
| 839437  | RFC-RFE 500-KM-A-Z    | 66  |
| 839439  | RFC-RFE 500-KM-A-AKV1 | 220 |
| 839440  | RFC-RFE 500-KM-A-AKV2 | 247 |
| 842273  | RFC-RFE 630-KM-Z      | 86  |
| 842275  | RFC-RFE 630-KM-AKV1   | 287 |
| 842276  | RFC-RFE 630-KM-AKV2   | 321 |
| 843098  | RFC-RFE 630-KM-A-Z    | 112 |
| 843100  | RFC-RFE 630-KM-A-AKV1 | 373 |
| 843101  | RFC-RFE 630-KM-A-AKV2 | 418 |
| <b>Vertikali variklio apsauga nuo lietaus</b> |                       |     |
| 841255  | SMO 63-Z              | 15  |
| 843103  | SMO 63-AKV1           | 48  |
| 843104  | SMO 63-AKV2           | 54  |
| 841256  | SMO 71-Z              | 17  |
| 843106  | SMO 71-AKV1           | 56  |
| 843107  | SMO 71-AKV2           | 62  |
| 841257  | SMO 80-Z              | 18  |
| 843109  | SMO 80-AKV1           | 60  |
| 843110  | SMO 80-AKV2           | 67  |
| 841258  | SMO 90-Z              | 21  |
| 843112  | SMO 90-AKV1           | 69  |
| 843113  | SMO 90-AKV2           | 78  |
| 841259  | SMO 100-Z             | 24  |
| 843115  | SMO 100-AKV1          | 79  |
| 843116  | SMO 100-AKV2          | 89  |
| 841260  | SMO 112-Z             | 27  |
| 843118  | SMO 112-AKV1          | 91  |
| 843119  | SMO 112-AKV2          | 102 |
| 841261  | SMO 132-Z             | 33  |
| 843121  | SMO 132-AKV1          | 109 |
| 843122  | SMO 132-AKV2          | 122 |
| 841262  | SMO 160-Z             | 41  |
| 843124  | SMO 160-AKV1          | 136 |
| 843125  | SMO 160-AKV2          | 152 |
| 842565  | SMO 180-Z             | 52  |
| 843127  | SMO 180-AKV1          | 172 |
| 843128  | SMO 180-AKV2          | 193 |
| <b>Perėjimas įsiurbio angai</b>               |                       |     |
| 25091   | RFC-RFE 200-NA1-Z     | 27  |
| 25391   | RFC-RFE 200-NA1-AKV1  | 89  |
| 832754  | RFC-RFE 200-NA1-AKV2  | 100 |
| 25092   | RFC-RFE 250-NA1-Z     | 32  |
| 25392   | RFC-RFE 250-NA1-AKV1  | 107 |
| 832767  | RFC-RFE 250-NA1-AKV2  | 119 |
| 25192   | RFC-RFE 280-NA1-Z     | 36  |
| 25194   | RFC-RFE 280-NA1-AKV1  | 119 |
| 832779  | RFC-RFE 280-NA1-AKV2  | 134 |
| 25093   | RFC-RFE 315-NA1-Z     | 40  |
| 25393   | RFC-RFE 315-NA1-AKV1  | 134 |
| 832795  | RFC-RFE 315-NA1-AKV2  | 150 |
| 25193   | RFC-RFE 355-NA1-Z     | 45  |
| 25195   | RFC-RFE 355-NA1-AKV1  | 148 |
| 832825  | RFC-RFE 355-NA1-AKV2  | 166 |
| 25094   | RFC-RFE 400-NA1-Z     | 49  |
| 25394   | RFC-RFE 400-NA1-AKV1  | 162 |

|           | A   |
|-----------|-----|
| SMO 63-Z  | 165 |
| SMO 71-Z  | 190 |
| SMO 80-Z  | 205 |
| SMO 90-Z  | 225 |
| SMO 100-Z | 245 |
| SMO 112-Z | 270 |
| SMO 132-Z | 310 |
| SMO 160-Z | 370 |
| SMO 180-Z | 450 |

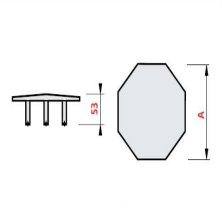





|                                  |                      |     |
|----------------------------------|----------------------|-----|
| 832851                           | RFC-RFE 400-NA1-AKV2 | 181 |
| 25095                            | RFC-RFE 500-NA1-Z    | 64  |
| 832880                           | RFC-RFE 500-NA1-AKV1 | 213 |
| 832881                           | RFC-RFE 500-NA1-AKV2 | 239 |
| 842277                           | RFC-RFE 630-NA1-Z    | 91  |
| 842279                           | RFC-RFE 630-NA1-AKV1 | 303 |
| 842280                           | RFC-RFE 630-NA1-AKV2 | 339 |
| Perėjimas su alkūne ir tinkleliu |                      |     |
| 25061                            | RFC-RFE 200-NA2-Z    | 18  |
| 25361                            | RFC-RFE 200-NA2-AKV1 | 59  |
| 832753                           | RFC-RFE 200-NA2-AKV2 | 66  |
| 25062                            | RFC-RFE 250-NA2-Z    | 21  |
| 25362                            | RFC-RFE 250-NA2-AKV1 | 70  |
| 832766                           | RFC-RFE 250-NA2-AKV2 | 78  |
| 25162                            | RFC-RFE 280-NA2-Z    | 24  |
| 25164                            | RFC-RFE 280-NA2-AKV1 | 80  |
| 832778                           | RFC-RFE 280-NA2-AKV2 | 90  |
| 25063                            | RFC-RFE 315-NA2-Z    | 27  |
| 25363                            | RFC-RFE 315-NA2-AKV1 | 89  |
| 832794                           | RFC-RFE 315-NA2-AKV2 | 100 |
| 25163                            | RFC-RFE 355-NA2-Z    | 30  |
| 25165                            | RFC-RFE 355-NA2-AKV1 | 99  |
| 832824                           | RFC-RFE 355-NA2-AKV2 | 111 |
| 25064                            | RFC-RFE 400-NA2-Z    | 32  |
| 25364                            | RFC-RFE 400-NA2-AKV1 | 107 |
| 832850                           | RFC-RFE 400-NA2-AKV2 | 120 |
| 25065                            | RFC-RFE 500-NA2-Z    | 40  |
| 832878                           | RFC-RFE 500-NA2-AKV1 | 134 |
| 832879                           | RFC-RFE 500-NA2-AKV2 | 150 |
| 842281                           | RFC-RFE 630-NA2-Z    | 55  |
| 842283                           | RFC-RFE 630-NA2-AKV1 | 184 |
| 842284                           | RFC-RFE 630-NA2-AKV2 | 206 |
| Perėjimas su alkūne ir tinkleliu |                      |     |
| 842558                           | RFC-RFE 200-NA3-Z    | 18  |
| 842579                           | RFC-RFE 200-NA3-AKV1 | 59  |
| 842580                           | RFC-RFE 200-NA3-AKV2 | 66  |
| 842559                           | RFC-RFE 250-NA3-Z    | 21  |
| 842582                           | RFC-RFE 250-NA3-AKV1 | 70  |
| 842583                           | RFC-RFE 250-NA3-AKV2 | 78  |
| 842560                           | RFC-RFE 280-NA3-Z    | 24  |
| 842585                           | RFC-RFE 280-NA3-AKV1 | 80  |
| 842586                           | RFC-RFE 280-NA3-AKV2 | 90  |
| 842561                           | RFC-RFE 315-NA3-Z    | 27  |
| 842588                           | RFC-RFE 315-NA3-AKV1 | 89  |
| 842589                           | RFC-RFE 315-NA3-AKV2 | 100 |
| 842562                           | RFC-RFE 355-NA3-Z    | 30  |
| 842591                           | RFC-RFE 355-NA3-AKV1 | 99  |
| 842592                           | RFC-RFE 355-NA3-AKV2 | 111 |
| 842563                           | RFC-RFE 400-NA3-Z    | 32  |
| 842594                           | RFC-RFE 400-NA3-AKV1 | 107 |
| 842595                           | RFC-RFE 400-NA3-AKV2 | 120 |
| 842564                           | RFC-RFE 500-NA3-Z    | 40  |
| 842597                           | RFC-RFE 500-NA3-AKV1 | 134 |
| 842598                           | RFC-RFE 500-NA3-AKV2 | 150 |
| 842285                           | RFC-RFE 630-NA3-Z    | 55  |
| 842287                           | RFC-RFE 630-NA3-AKV1 | 184 |
| 842288                           | RFC-RFE 630-NA3-AKV2 | 206 |

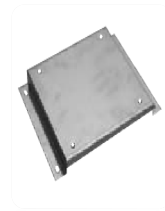

| Amortizacinis pagrindas  |                          |     |
|--------------------------|--------------------------|-----|
| 25001                    | RFC-RFE 200-PD-Z         | 9   |
| 25301                    | RFC-RFE 200-PD-AKV1      | 29  |
| 832750                   | RFC-RFE 200-PD-AKV2      | 33  |
| 25002                    | RFC-RFE 250-PD-Z         | 12  |
| 25302                    | RFC-RFE 250-PD-AKV1      | 41  |
| 832763                   | RFC-RFE 250-PD-AKV2      | 46  |
| 25102                    | RFC-RFE 280-PD-Z         | 14  |
| 25104                    | RFC-RFE 280-PD-AKV1      | 47  |
| 832775                   | RFC-RFE 280-PD-AKV2      | 52  |
| 25003                    | RFC-RFE 315-PD-Z         | 16  |
| 25303                    | RFC-RFE 315-PD-AKV1      | 54  |
| 832006                   | RFC-RFE 315-PD-AKV2      | 61  |
| 25103                    | RFC-RFE 355-PD-Z         | 20  |
| 25105                    | RFC-RFE 355-PD-AKV1      | 66  |
| 832821                   | RFC-RFE 355-PD-AKV2      | 74  |
| 25004                    | RFC-RFE 400-PD-Z         | 23  |
| 25304                    | RFC-RFE 400-PD-AKV1      | 78  |
| 832847                   | RFC-RFE 400-PD-AKV2      | 87  |
| 25005                    | RFC-RFE 500-PD-Z         | 29  |
| 831959                   | RFC-RFE 500-PD-AKV1      | 98  |
| 832874                   | RFC-RFE 500-PD-AKV2      | 110 |
| 842269                   | RFC-RFE 630-PD-Z         | 68  |
| 842271                   | RFC-RFE 630-PD-AKV1      | 225 |
| 842272                   | RFC-RFE 630-PD-AKV2      | 252 |
| Lanksti jungtis - apvali |                          |     |
| 25071                    | RFC-RFE 200-PVS          | 24  |
| 832598                   | RFC-RFE 200-PVS-Ex1      | 31  |
| 25371                    | RFC-RFE 200-PVS-AKV1     | 80  |
| 832612                   | RFC-RFE 200-PVS-AKV1-Ex1 | 104 |
| 832719                   | RFC-RFE 200-PVS-AKV2     | 89  |
| 832731                   | RFC-RFE 200-PVS-AKV2-Ex1 | 116 |
| 25072                    | RFC-RFE 250-PVS          | 32  |
| 832599                   | RFC-RFE 250-PVS-Ex1      | 42  |
| 25372                    | RFC-RFE 250-PVS-AKV1     | 106 |
| 832613                   | RFC-RFE 250-PVS-AKV1-Ex1 | 138 |
| 832720                   | RFC-RFE 250-PVS-AKV2     | 119 |
| 832732                   | RFC-RFE 250-PVS-AKV2-Ex1 | 155 |
| 25172                    | RFC-RFE 280-PVS          | 35  |
| 832600                   | RFC-RFE 280-PVS-Ex1      | 45  |
| 25174                    | RFC-RFE 280-PVS-AKV1     | 115 |
| 832614                   | RFC-RFE 280-PVS-AKV1-Ex1 | 150 |
| 832721                   | RFC-RFE 280-PVS-AKV2     | 129 |
| 832733                   | RFC-RFE 280-PVS-AKV2-Ex1 | 167 |
| 25073                    | RFC-RFE 315-PVS          | 38  |
| 832601                   | RFC-RFE 315-PVS-Ex1      | 49  |
| 25373                    | RFC-RFE 315-PVS-AKV1     | 125 |
| 832615                   | RFC-RFE 315-PVS-AKV1-Ex1 | 162 |
| 832008                   | RFC-RFE 315-PVS-AKV2     | 140 |
| 832734                   | RFC-RFE 315-PVS-AKV2-Ex1 | 182 |
| 25173                    | RFC-RFE 355-PVS          | 43  |
| 832602                   | RFC-RFE 355-PVS-Ex1      | 56  |
| 25175                    | RFC-RFE 355-PVS-AKV1     | 143 |
| 832616                   | RFC-RFE 355-PVS-AKV1-Ex1 | 186 |
| 832722                   | RFC-RFE 355-PVS-AKV2     | 160 |
| 832735                   | RFC-RFE 355-PVS-AKV2-Ex1 | 208 |
| 25074                    | RFC-RFE 400-PVS          | 49  |
| 832603                   | RFC-RFE 400-PVS-Ex1      | 64  |



|                                      |                          |     |
|--------------------------------------|--------------------------|-----|
| 25374                                | RFC-RFE 400-PVS-AKV1     | 164 |
| 832617                               | RFC-RFE 400-PVS-AKV1-Ex1 | 213 |
| 832723                               | RFC-RFE 400-PVS-AKV2     | 183 |
| 832736                               | RFC-RFE 400-PVS-AKV2-Ex1 | 238 |
| 25075                                | RFC-RFE 500-PVS          | 65  |
| 832604                               | RFC-RFE 500-PVS-Ex1      | 84  |
| 831952                               | RFC-RFE 500-PVS-AKV1     | 215 |
| 832618                               | RFC-RFE 500-PVS-AKV1-Ex1 | 279 |
| 832724                               | RFC-RFE 500-PVS-AKV2     | 240 |
| 832737                               | RFC-RFE 500-PVS-AKV2-Ex1 | 312 |
| 842289                               | RFC-RFE 630-PVS          | 73  |
| 842292                               | RFC-RFE 630-PVS-Ex1      | 95  |
| 842290                               | RFC-RFE 630-PVS-AKV1     | 242 |
| 842293                               | RFC-RFE 630-PVS-AKV1-Ex1 | 315 |
| 842291                               | RFC-RFE 630-PVS-AKV2     | 271 |
| 842294                               | RFC-RFE 630-PVS-AKV2-Ex1 | 353 |
| <b>Lankstij jungtis - kvadratinė</b> |                          |     |
| 25081                                | RFC-RFE 200-PV           | 20  |
| 832605                               | RFC-RFE 200-PV-Ex1       | 25  |
| 25381                                | RFC-RFE 200-PV-AKV1      | 65  |
| 832619                               | RFC-RFE 200-PV-AKV1-Ex1  | 85  |
| 832725                               | RFC-RFE 200-PV-AKV2      | 73  |
| 832738                               | RFC-RFE 200-PV-AKV2-Ex1  | 95  |
| 25082                                | RFC-RFE 250-PV           | 23  |
| 832606                               | RFC-RFE 250-PV-Ex1       | 29  |
| 25382                                | RFC-RFE 250-PV-AKV1      | 75  |
| 832620                               | RFC-RFE 250-PV-AKV1-Ex1  | 98  |
| 832726                               | RFC-RFE 250-PV-AKV2      | 84  |
| 832739                               | RFC-RFE 250-PV-AKV2-Ex1  | 110 |
| 25182                                | RFC-RFE 280-PV           | 24  |
| 832607                               | RFC-RFE 280-PV-Ex1       | 32  |
| 25184                                | RFC-RFE 280-PV-AKV1      | 80  |
| 832621                               | RFC-RFE 280-PV-AKV1-Ex1  | 105 |
| 832727                               | RFC-RFE 280-PV-AKV2      | 90  |
| 832740                               | RFC-RFE 280-PV-AKV2-Ex1  | 117 |
| 25083                                | RFC-RFE 315-PV           | 25  |
| 832608                               | RFC-RFE 315-PV-Ex1       | 33  |
| 25383                                | RFC-RFE 315-PV-AKV1      | 84  |
| 832622                               | RFC-RFE 315-PV-AKV1-Ex1  | 109 |
| 832007                               | RFC-RFE 315-PV-AKV2      | 94  |
| 832741                               | RFC-RFE 315-PV-AKV2-Ex1  | 122 |
| 25183                                | RFC-RFE 355-PV           | 29  |
| 832609                               | RFC-RFE 355-PV-Ex1       | 37  |
| 25185                                | RFC-RFE 355-PV-AKV1      | 96  |
| 832623                               | RFC-RFE 355-PV-AKV1-Ex1  | 124 |
| 832728                               | RFC-RFE 355-PV-AKV2      | 107 |
| 832742                               | RFC-RFE 355-PV-AKV2-Ex1  | 139 |
| 25084                                | RFC-RFE 400-PV           | 32  |
| 832610                               | RFC-RFE 400-PV-Ex1       | 41  |
| 25384                                | RFC-RFE 400-PV-AKV1      | 106 |
| 832624                               | RFC-RFE 400-PV-AKV1-Ex1  | 137 |
| 832729                               | RFC-RFE 400-PV-AKV2      | 118 |
| 832743                               | RFC-RFE 400-PV-AKV2-Ex1  | 154 |
| 25085                                | RFC-RFE 500-PV           | 36  |
| 832611                               | RFC-RFE 500-PV-Ex1       | 47  |
| 831953                               | RFC-RFE 500-PV-AKV1      | 121 |
| 832625                               | RFC-RFE 500-PV-AKV1-Ex1  | 158 |
| 832730                               | RFC-RFE 500-PV-AKV2      | 136 |



|        |                         |     |
|--------|-------------------------|-----|
| 832744 | RFC-RFE 500-PV-AKV2-Ex1 | 176 |
| 842295 | RFC-RFE 630-PV          | 42  |
| 842298 | RFC-RFE 630-PV-Ex1      | 54  |
| 842296 | RFC-RFE 630-PV-AKV1     | 138 |
| 842299 | RFC-RFE 630-PV-AKV1-Ex1 | 180 |
| 842297 | RFC-RFE 630-PV-AKV2     | 155 |

### KANALINIAI VENTILIATORIAI TERNO-S

**TERNO-S...K,KB-IP-55** Darbinė temperatūra: -30+85 °C, Ex -30+40 °C

**TERNO-S...K,KB-VTR-IP-54** Darbinė temperatūra: -30+40 °C, Ex -30+40 °C

Greičio  
reguliatorius



**TERNO-S  
200**

| CINKUOTAS PLIENAS |                                     |      |
|-------------------|-------------------------------------|------|
| 11041             | TERNO-S 200 K-15/0,18-3-Z           | 318  |
| 11042             | TERNO-S 200 K-15/0,18-3-Z-Ex1       | 424  |
| 11071             | TERNO-S 200 K-15/0,12-VTR-Z         | 396  |
| 838656            | TERNO-S 200 K-15/0,25-3-Z-Ex1-FM    | 948  |
| 11061             | TERNO-S 200 K-30/1,1-3-Z            | 389  |
| 11062             | TERNO-S 200 K-30/1,1-3-Z-Ex1        | 780  |
| 838668            | TERNO-S 200 K-30/1,1-3-Z-Ex1-FM     | 1063 |
| 11141             | TERNO-S 200 KB-15/0,18-3-P-Z        | 429  |
| 11241             | TERNO-S 200 KB-15/0,18-3-L-Z        | 323  |
| 11142             | TERNO-S 200 KB-15/0,18-3-P-Z-Ex1    | 429  |
| 11242             | TERNO-S 200 KB-15/0,18-3-L-Z-Ex1    | 429  |
| 11171             | TERNO-S 200 KB-15/0,12-VTR-P-Z      | 437  |
| 11271             | TERNO-S 200 KB-15/0,12-VTR-L-Z      | 437  |
| 838658            | TERNO-S 200 KB-15/0,25-3-P-Z-Ex1-FM | 953  |
| 838660            | TERNO-S 200 KB-15/0,25-3-L-Z-Ex1-FM | 953  |
| 11161             | TERNO-S 200 KB-30/1,1-3-P-Z         | 394  |
| 11261             | TERNO-S 200 KB-30/1,1-3-L-Z         | 394  |
| 11162             | TERNO-S 200 KB-30/1,1-3-P-Z-Ex1     | 780  |
| 11262             | TERNO-S 200 KB-30/1,1-3-L-Z-Ex1     | 780  |
| 838670            | TERNO-S 200 KB-30/1,1-3-P-Z-Ex1-FM  | 1067 |
| 838672            | TERNO-S 200 KB-30/1,1-3-L-Z-Ex1-FM  | 1067 |

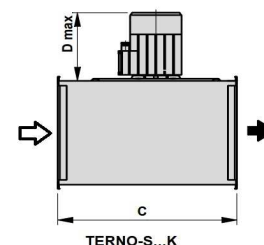

**AKV1**

| Nerūdijantis plienas - EN 10088/1-3-95 (AISI 304) maisto, farmacijos pramonei |  |      |
|---|--|------|
| 838812  | TERNO-S 200 K-15/0,18-3-AKV1           | 691  |
| 838818  | TERNO-S 200 K-15/0,18-3-AKV1-Ex1       | 911  |
| 838824  | TERNO-S 200 K-15/0,12-VTR-AKV1         | 830  |
| 838836  | TERNO-S 200 K-15/0,25-3-AKV1-Ex1-FM    | 1435 |
| 838842  | TERNO-S 200 K-30/1,1-3-AKV1            | 786  |
| 838848  | TERNO-S 200 K-30/1,1-3-AKV1-Ex1        | 1262 |
| 838860  | TERNO-S 200 K-30/1,1-3-AKV1-Ex1-FM     | 1550 |
| 838814  | TERNO-S 200 KB-15/0,18-3-P-AKV1        | 707  |
| 838816  | TERNO-S 200 KB-15/0,18-3-L-AKV1        | 707  |
| 838820  | TERNO-S 200 KB-15/0,18-3-P-AKV1-Ex1    | 928  |
| 838822  | TERNO-S 200 KB-15/0,18-3-L-AKV1-Ex1    | 928  |
| 838826  | TERNO-S 200 KB-15/0,12-VTR-P-AKV1      | 845  |
| 838828  | TERNO-S 200 KB-15/0,12-VTR-L-AKV1      | 845  |
| 838838  | TERNO-S 200 KB-15/0,25-3-P-AKV1-Ex1-FM | 1452 |
| 838840  | TERNO-S 200 KB-15/0,25-3-L-AKV1-Ex1-FM | 1452 |
| 838844  | TERNO-S 200 KB-30/1,1-3-P-AKV1         | 802  |
| 838846  | TERNO-S 200 KB-30/1,1-3-L-AKV1         | 802  |
| 838850  | TERNO-S 200 KB-30/1,1-3-P-AKV1-Ex1     | 1262 |
| 838852  | TERNO-S 200 KB-30/1,1-3-L-AKV1-Ex1     | 1262 |
| 838862  | TERNO-S 200 KB-30/1,1-3-P-AKV1-Ex1-FM  | 1566 |
| 838864  | TERNO-S 200 KB-30/1,1-3-L-AKV1-Ex1-FM  | 1566 |

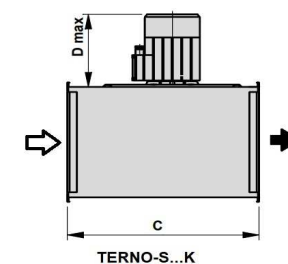

**AKV2**

| Nerūdijantis plienas - EN 10088-95 (AISI 316) chemijos pramonei |                                  |     |
|---|----------------------------------|-----|
| 838813  | TERNO-S 200 K-15/0,18-3-AKV2     | 761 |
| 838819  | TERNO-S 200 K-15/0,18-3-AKV2-Ex1 | 996 |
| 838825  | TERNO-S 200 K-15/0,12-VTR-AKV2   | 900 |

|  |  |      |
|--|--|------|
| 838837   | TERNO-S 200 K-15/0,25-3-AKV2-Ex1-FM    | 1520 |
| 838843   | TERNO-S 200 K-30/1,1-3-AKV2            | 856  |
| 838849   | TERNO-S 200 K-30/1,1-3-AKV2-Ex1        | 1347 |
| 838861   | TERNO-S 200 K-30/1,1-3-AKV2-Ex1-FM     | 1634 |
| 838815   | TERNO-S 200 KB-15/0,18-3-P-AKV2        | 779  |
| 838817   | TERNO-S 200 KB-15/0,18-3-L-AKV2        | 779  |
| 838821   | TERNO-S 200 KB-15/0,18-3-P-AKV2-Ex1    | 1014 |
| 838823   | TERNO-S 200 KB-15/0,18-3-L-AKV2-Ex1    | 1014 |
| 838827   | TERNO-S 200 KB-15/0,12-VTR-P-AKV2      | 918  |
| 838829   | TERNO-S 200 KB-15/0,12-VTR-L-AKV2      | 918  |
| 838839   | TERNO-S 200 KB-15/0,25-3-P-AKV2-Ex1-FM | 1538 |
| 838841   | TERNO-S 200 KB-15/0,25-3-L-AKV2-Ex1-FM | 1538 |
| 838845   | TERNO-S 200 KB-30/1,1-3-P-AKV2         | 874  |
| 838847   | TERNO-S 200 KB-30/1,1-3-L-AKV2         | 874  |
| 838851   | TERNO-S 200 KB-30/1,1-3-P-AKV2-Ex1     | 1365 |
| 838853   | TERNO-S 200 KB-30/1,1-3-L-AKV2-Ex1     | 1365 |
| 838863   | TERNO-S 200 KB-30/1,1-3-P-AKV2-Ex1-FM  | 1652 |
| 838865   | TERNO-S 200 KB-30/1,1-3-L-AKV2-Ex1-FM  | 1652 |
| <b>CINKUOTAS PLIENAS</b>   |  |      |
| 14041  | TERNO-S 250 K-15/0,37-3-Z              | 413  |
| 14042  | TERNO-S 250 K-15/0,37-3-Z-Ex1          | 770  |
| 14071  | TERNO-S 250 K-15/0,45-VTR-Z            | 522  |
| 838680   | TERNO-S 250 K-15/0,37-3-Z-Ex1-FM       | 1061 |
| 14141  | TERNO-S 250 KB-15/0,37-3-P-Z           | 420  |
| 14241  | TERNO-S 250 KB-15/0,37-3-L-Z           | 420  |
| 14142  | TERNO-S 250 KB-15/0,37-3-P-Z-Ex1       | 778  |
| 14242  | TERNO-S 250 KB-15/0,37-3-L-Z-Ex1       | 778  |
| 14171  | TERNO-S 250 KB-15/0,45-VTR-P-Z         | 530  |
| 14271  | TERNO-S 250 KB-15/0,45-VTR-L-Z         | 530  |
| 838682   | TERNO-S 250 KB-15/0,37-3-P-Z-Ex1-FM    | 1068 |
| 838684   | TERNO-S 250 KB-15/0,37-3-L-Z-Ex1-FM    | 1068 |
| <i>Nerūdijantis plienas - EN 10088/1-3-95 (AISI 304) maisto, farmacijos pramonei</i> |  |      |
| 838872   | TERNO-S 250 K-15/0,37-3-AKV1           | 979  |
| 838878   | TERNO-S 250 K-15/0,37-3-AKV1-Ex1       | 1479 |
| 838884   | TERNO-S 250 K-15/0,45-VTR-AKV1         | 1188 |
| 838896   | TERNO-S 250 K-15/0,37-3-AKV1-Ex1-FM    | 1770 |
| 838874   | TERNO-S 250 KB-15/0,37-3-P-AKV1        | 1004 |
| 838876   | TERNO-S 250 KB-15/0,37-3-L-AKV1        | 1004 |
| 838880   | TERNO-S 250 KB-15/0,37-3-P-AKV1-Ex1    | 1504 |
| 838882   | TERNO-S 250 KB-15/0,37-3-L-AKV1-Ex1    | 1504 |
| 838886   | TERNO-S 250 KB-15/0,45-VTR-P-AKV1      | 1213 |
| 838888   | TERNO-S 250 KB-15/0,45-VTR-L-AKV1      | 1213 |
| 838898   | TERNO-S 250 KB-15/0,37-3-P-AKV1-Ex1-FM | 1794 |
| 838900   | TERNO-S 250 KB-15/0,37-3-L-AKV1-Ex1-FM | 1794 |
| <i>Nerūdijantis plienas - EN 10088-95 (AISI 316) chemijos pramonei</i>               |  |      |
| 838873   | TERNO-S 250 K-15/0,37-3-AKV2           | 1082 |
| 838879   | TERNO-S 250 K-15/0,37-3-AKV2-Ex1       | 1602 |
| 838885   | TERNO-S 250 K-15/0,45-VTR-AKV2         | 1291 |
| 838897   | TERNO-S 250 K-15/0,37-3-AKV2-Ex1-FM    | 1892 |
| 838875   | TERNO-S 250 KB-15/0,37-3-P-AKV2        | 1109 |
| 838877   | TERNO-S 250 KB-15/0,37-3-L-AKV2        | 1109 |
| 838881   | TERNO-S 250 KB-15/0,37-3-P-AKV2-Ex1    | 1629 |
| 838883   | TERNO-S 250 KB-15/0,37-3-L-AKV2-Ex1    | 1629 |
| 838887   | TERNO-S 250 KB-15/0,45-VTR-P-AKV2      | 1318 |
| 838889   | TERNO-S 250 KB-15/0,45-VTR-L-AKV2      | 1318 |
| 838899   | TERNO-S 250 KB-15/0,37-3-P-AKV2-Ex1-FM | 1920 |
| 838901   | TERNO-S 250 KB-15/0,37-3-L-AKV2-Ex1-FM | 1920 |

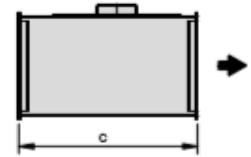

TERNO-S...VTR

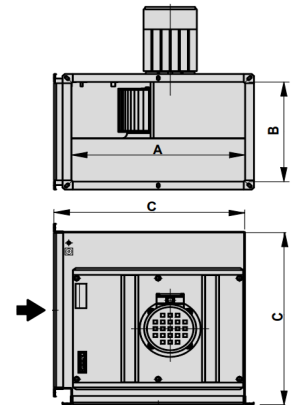

TERNO-S...KB

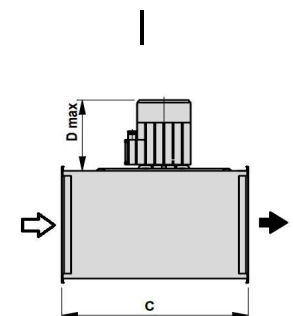

TERNO-S...K

TERNO-S 250

AKV1

AKV2

TERNO-  
S 280

| CINKUOTAS PLIENAS |                                     |      |
|-------------------|-------------------------------------|------|
| 832890            | TERNO-S 280 K-10/0,37-3-Z           | 546  |
| 832891            | TERNO-S 280 K-10/0,37-3-Z-Ex1       | 921  |
| 17061             | TERNO-S 280 K-10/0,22-VTR-Z         | 619  |
| 838692            | TERNO-S 280 K-10/0,37-3-Z-Ex1-FM    | 1271 |
| 17051             | TERNO-S 280 K-15/0,75-3-Z           | 576  |
| 17052             | TERNO-S 280 K-15/0,75-3-Z-Ex1       | 970  |
| 17071             | TERNO-S 280 K-15/0,6-VTR-Z          | 720  |
| 838704            | TERNO-S 280 K-15/0,75-3-Z-Ex1-FM    | 1277 |
| 832892            | TERNO-S 280 KB-10/0,37-3-P-Z        | 556  |
| 832894            | TERNO-S 280 KB-10/0,37-3-L-Z        | 556  |
| 832893            | TERNO-S 280 KB-10/0,37-3-P-Z-Ex1    | 931  |
| 832895            | TERNO-S 280 KB-10/0,37-3-L-Z-Ex1    | 931  |
| 17161             | TERNO-S 280 KB-10/0,22-VTR-P-Z      | 629  |
| 17261             | TERNO-S 280 KB-10/0,22-VTR-L-Z      | 629  |
| 838694            | TERNO-S 280 KB-10/0,37-3-P-Z-Ex1-FM | 1281 |
| 838696            | TERNO-S 280 KB-10/0,37-3-L-Z-Ex1-FM | 1281 |
| 17151             | TERNO-S 280 KB-15/0,75-3-P-Z        | 586  |
| 17251             | TERNO-S 280 KB-15/0,75-3-L-Z        | 586  |
| 17152             | TERNO-S 280 KB-15/0,75-3-P-Z-Ex1    | 980  |
| 17252             | TERNO-S 280 KB-15/0,75-3-L-Z-Ex1    | 980  |
| 17171             | TERNO-S 280 KB-15/0,6-VTR-P-Z       | 730  |
| 17271             | TERNO-S 280 KB-15/0,6-VTR-L-Z       | 730  |
| 838706            | TERNO-S 280 KB-15/0,75-3-P-Z-Ex1-FM | 1286 |
| 838708            | TERNO-S 280 KB-15/0,75-3-L-Z-Ex1-FM | 1286 |

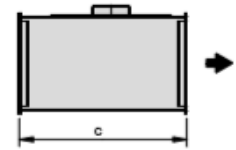

TERNO-S...VTR

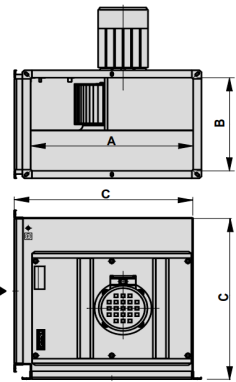

TERNO-S...KB

AKV1

| Nerūdijantis plienas - EN 10088/1-3-95 (AISI 304) maisto, farmācijas pramonei |  |      |
|---|--|------|
| 838902  | TERNO-S 280 K-10/0,37-3-AKV1           | 1300 |
| 838908  | TERNO-S 280 K-10/0,37-3-AKV1-Ex1       | 1837 |
| 838914  | TERNO-S 280 K-10/0,22-VTR-AKV1         | 1486 |
| 838926  | TERNO-S 280 K-10/0,37-3-AKV1-Ex1-FM    | 2186 |
| 838938  | TERNO-S 280 K-15/0,75-3-AKV1           | 1336 |
| 838944  | TERNO-S 280 K-15/0,75-3-AKV1-Ex1       | 1886 |
| 838950  | TERNO-S 280 K-15/0,6-VTR-AKV1          | 1505 |
| 838962  | TERNO-S 280 K-15/0,75-3-AKV1-Ex1-FM    | 2192 |
| 838904  | TERNO-S 280 KB-10/0,37-3-P-AKV1        | 1355 |
| 838906  | TERNO-S 280 KB-10/0,37-3-L-AKV1        | 1355 |
| 838910  | TERNO-S 280 KB-10/0,37-3-P-AKV1-Ex1    | 1870 |
| 838912  | TERNO-S 280 KB-10/0,37-3-L-AKV1-Ex1    | 1870 |
| 838916  | TERNO-S 280 KB-10/0,22-VTR-P-AKV1      | 1541 |
| 838918  | TERNO-S 280 KB-10/0,22-VTR-L-AKV1      | 1541 |
| 838928  | TERNO-S 280 KB-10/0,37-3-P-AKV1-Ex1-FM | 2220 |
| 838930  | TERNO-S 280 KB-10/0,37-3-L-AKV1-Ex1-FM | 2220 |
| 838940  | TERNO-S 280 KB-15/0,75-3-P-AKV1        | 1369 |
| 838942  | TERNO-S 280 KB-15/0,75-3-L-AKV1        | 1369 |
| 838946  | TERNO-S 280 KB-15/0,75-3-P-AKV1-Ex1    | 1919 |
| 838948  | TERNO-S 280 KB-15/0,75-3-L-AKV1-Ex1    | 1919 |
| 838952  | TERNO-S 280 KB-15/0,6-VTR-P-AKV1       | 1538 |
| 838954  | TERNO-S 280 KB-15/0,6-VTR-L-AKV1       | 1538 |
| 838964  | TERNO-S 280 KB-15/0,75-3-P-AKV1-Ex1-FM | 2225 |
| 838966  | TERNO-S 280 KB-15/0,75-3-L-AKV1-Ex1-FM | 2225 |

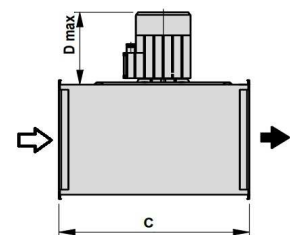

TERNO-S...K

AKV2

| Nerūdijantis plienas - EN 10088-95 (AISI 316) chemijas pramonei |                                     |      |
|---|-------------------------------------|------|
| 838903  | TERNO-S 280 K-10/0,37-3-AKV2        | 1436 |
| 838909  | TERNO-S 280 K-10/0,37-3-AKV2-Ex1    | 1999 |
| 838915  | TERNO-S 280 K-10/0,22-VTR-AKV2      | 1621 |
| 838927  | TERNO-S 280 K-10/0,37-3-AKV2-Ex1-FM | 2349 |
| 838939  | TERNO-S 280 K-15/0,75-3-AKV2        | 1450 |
| 838945  | TERNO-S 280 K-15/0,75-3-AKV2-Ex1    | 2048 |
| 838951  | TERNO-S 280 K-15/0,6-VTR-AKV2       | 1635 |

|        |  |      |
|--------|--|------|
| 838963 | TERNO-S 280 K-15/0,75-3-AKV2-Ex1-FM    | 2354 |
| 838905 | TERNO-S 280 KB-10/0,37-3-P-AKV2        | 1473 |
| 838907 | TERNO-S 280 KB-10/0,37-3-L-AKV2        | 1473 |
| 838911 | TERNO-S 280 KB-10/0,37-3-P-AKV2-Ex1    | 2036 |
| 838913 | TERNO-S 280 KB-10/0,37-3-L-AKV2-Ex1    | 2036 |
| 838917 | TERNO-S 280 KB-10/0,22-VTR-P-AKV2      | 1658 |
| 838919 | TERNO-S 280 KB-10/0,22-VTR-L-AKV2      | 1658 |
| 838929 | TERNO-S 280 KB-10/0,37-3-P-AKV2-Ex1-FM | 2386 |
| 838931 | TERNO-S 280 KB-10/0,37-3-L-AKV2-Ex1-FM | 2386 |
| 838941 | TERNO-S 280 KB-15/0,75-3-P-AKV2        | 1487 |
| 838943 | TERNO-S 280 KB-15/0,75-3-L-AKV2        | 1487 |
| 838947 | TERNO-S 280 KB-15/0,75-3-P-AKV2-Ex1    | 2085 |
| 838949 | TERNO-S 280 KB-15/0,75-3-L-AKV2-Ex1    | 2085 |
| 838953 | TERNO-S 280 KB-15/0,6-VTR-P-AKV2       | 1656 |
| 838955 | TERNO-S 280 KB-15/0,6-VTR-L-AKV2       | 1656 |
| 838965 | TERNO-S 280 KB-15/0,75-3-P-AKV2-Ex1-FM | 2392 |
| 838967 | TERNO-S 280 KB-15/0,75-3-L-AKV2-Ex1-FM | 2392 |

TERNO-S 315

| CINKUOTAS PLIENAS |                                    |      |
|-------------------|------------------------------------|------|
| 13041             | TERNO-S 315 K-10/1,1-3-Z           | 767  |
| 13042             | TERNO-S 315 K-10/0,95-3-Z-Ex1      | 1172 |
| 13061             | TERNO-S 315 K-10/0,92-VTR-Z        | 848  |
| 838716            | TERNO-S 315 K-10/1,1-3-Z-Ex1-FM    | 1620 |
| 13051             | TERNO-S 315 K-15/1,5-3-Z           | 753  |
| 13052             | TERNO-S 315 K-15/1,35-3-Z-Ex1      | 1177 |
| 13071             | TERNO-S 315 K-15/1,5-VTR-Z         | 945  |
| 838728            | TERNO-S 315 K-15/1,5-3-Z-Ex1-FM    | 1603 |
| 13141             | TERNO-S 315 KB-10/1,1-3-P-Z        | 782  |
| 13241             | TERNO-S 315 KB-10/1,1-3-L-Z        | 782  |
| 13142             | TERNO-S 315 KB-10/0,95-3-P-Z-Ex1   | 1187 |
| 13242             | TERNO-S 315 KB-10/0,95-3-L-Z-Ex1   | 1187 |
| 13161             | TERNO-S 315 KB-10/0,92-VTR-P-Z     | 863  |
| 13261             | TERNO-S 315 KB-10/0,92-VTR-L-Z     | 863  |
| 838718            | TERNO-S 315 KB-10/1,1-3-P-Z-Ex1-FM | 1635 |
| 838720            | TERNO-S 315 KB-10/1,1-3-L-Z-Ex1-FM | 1635 |
| 13151             | TERNO-S 315 KB-15/1,5-3-P-Z        | 768  |
| 13251             | TERNO-S 315 KB-15/1,5-3-L-Z        | 768  |
| 13152             | TERNO-S 315 KB-15/1,35-3-P-Z-Ex1   | 1192 |
| 13252             | TERNO-S 315 KB-15/1,35-3-L-Z-Ex1   | 1192 |
| 13171             | TERNO-S 315 KB-15/1,5-VTR-P-Z      | 960  |
| 13271             | TERNO-S 315 KB-15/1,5-VTR-L-Z      | 960  |
| 838730            | TERNO-S 315 KB-15/1,5-3-P-Z-Ex1-FM | 1618 |
| 838732            | TERNO-S 315 KB-15/1,5-3-L-Z-Ex1-FM | 1618 |

AKV1

| Nerūdijantis plienas - EN 10088/1-3-95 (AISI 304) maisto, farmacijos pramonei |                                       |      |
|---|---------------------------------------|------|
| 838968  | TERNO-S 315 K-10/1,1-3-AKV1           | 1685 |
| 838974  | TERNO-S 315 K-10/0,95-3-AKV1-Ex1      | 2274 |
| 838980  | TERNO-S 315 K-10/0,92-VTR-AKV1        | 1894 |
| 838992  | TERNO-S 315 K-10/1,1-3-AKV1-Ex1-FM    | 2722 |
| 838998  | TERNO-S 315 K-15/1,5-3-AKV1           | 1671 |
| 839004  | TERNO-S 315 K-15/1,35-3-AKV1-Ex1      | 2278 |
| 839010  | TERNO-S 315 K-15/1,5-VTR-AKV1         | 1917 |
| 839022  | TERNO-S 315 K-15/1,5-3-AKV1-Ex1-FM    | 2705 |
| 838970  | TERNO-S 315 KB-10/1,1-3-P-AKV1        | 1735 |
| 838972  | TERNO-S 315 KB-10/1,1-3-L-AKV1        | 1735 |
| 838976  | TERNO-S 315 KB-10/0,95-3-P-AKV1-Ex1   | 2324 |
| 838978  | TERNO-S 315 KB-10/0,95-3-L-AKV1-Ex1   | 2324 |
| 838982  | TERNO-S 315 KB-10/0,92-VTR-P-AKV1     | 1943 |
| 838984  | TERNO-S 315 KB-10/0,92-VTR-L-AKV1     | 1943 |
| 838994  | TERNO-S 315 KB-10/1,1-3-P-AKV1-Ex1-FM | 2772 |

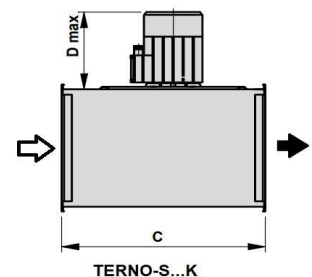
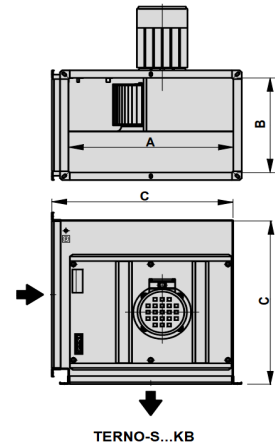

|  |                                       |      |
|--|---------------------------------------|------|
| 838996   | TERNO-S 315 KB-10/1,1-3-L-AKV1-Ex1-FM | 2772 |
| 839000   | TERNO-S 315 KB-15/1,5-3-P-AKV1        | 1721 |
| 839002   | TERNO-S 315 KB-15/1,5-3-L-AKV1        | 1721 |
| 839006   | TERNO-S 315 KB-15/1,35-3-P-AKV1-Ex1   | 2329 |
| 839008   | TERNO-S 315 KB-15/1,35-3-L-AKV1-Ex1   | 2329 |
| 839012   | TERNO-S 315 KB-15/1,5-VTR-P-AKV1      | 1967 |
| 839014   | TERNO-S 315 KB-15/1,5-VTR-L-AKV1      | 1967 |
| 839024   | TERNO-S 315 KB-15/1,5-3-P-AKV1-Ex1-FM | 2755 |
| 839026   | TERNO-S 315 KB-15/1,5-3-L-AKV1-Ex1-FM | 2755 |
| <b>Nerūdijantis plienas - EN 10088-95 (AISI 316) chemijos pramonei</b>               |                                       |      |
| 838969   | TERNO-S 315 K-10/1,1-3-AKV2           | 1853 |
| 838975   | TERNO-S 315 K-10/0,95-3-AKV2-Ex1      | 2476 |
| 838981   | TERNO-S 315 K-10/0,92-VTR-AKV2        | 2061 |
| 838993   | TERNO-S 315 K-10/1,1-3-AKV2-Ex1-FM    | 2924 |
| 838999   | TERNO-S 315 K-15/1,5-3-AKV2           | 1839 |
| 839005   | TERNO-S 315 K-15/1,35-3-AKV2-Ex1      | 2480 |
| 839011   | TERNO-S 315 K-15/1,5-VTR-AKV2         | 2085 |
| 839023   | TERNO-S 315 K-15/1,5-3-AKV2-Ex1-FM    | 2907 |
| 838971   | TERNO-S 315 KB-10/1,1-3-P-AKV2        | 1909 |
| 838973   | TERNO-S 315 KB-10/1,1-3-L-AKV2        | 1909 |
| 838977   | TERNO-S 315 KB-10/0,95-3-P-AKV2-Ex1   | 2532 |
| 838979   | TERNO-S 315 KB-10/0,95-3-L-AKV2-Ex1   | 2532 |
| 838983   | TERNO-S 315 KB-10/0,92-VTR-P-AKV2     | 2117 |
| 838985   | TERNO-S 315 KB-10/0,92-VTR-L-AKV2     | 2117 |
| 838995   | TERNO-S 315 KB-10/1,1-3-P-AKV2-Ex1-FM | 2980 |
| 838997   | TERNO-S 315 KB-10/1,1-3-L-AKV2-Ex1-FM | 2980 |
| 839001   | TERNO-S 315 KB-15/1,5-3-P-AKV2        | 1895 |
| 839003   | TERNO-S 315 KB-15/1,5-3-L-AKV2        | 1895 |
| 839007   | TERNO-S 315 KB-15/1,35-3-P-AKV2-Ex1   | 2536 |
| 839009   | TERNO-S 315 KB-15/1,35-3-L-AKV2-Ex1   | 2536 |
| 839013   | TERNO-S 315 KB-15/1,5-VTR-P-AKV2      | 2141 |
| 839015   | TERNO-S 315 KB-15/1,5-VTR-L-AKV2      | 2141 |
| 839025   | TERNO-S 315 KB-15/1,5-3-P-AKV2-Ex1-FM | 2962 |
| 839027   | TERNO-S 315 KB-15/1,5-3-L-AKV2-Ex1-FM | 2962 |
| <b>CINKUOTAS PLIENAS</b>   |                                       |      |
| 18041  | TERNO-S 355 K-10/1,5-3-Z              | 995  |
| 18042  | TERNO-S 355 K-10/1,3-3-Z-Ex1          | 1419 |
| 18061  | TERNO-S 355 K-10/1,25-VTR-Z           | 1071 |
| 838740   | TERNO-S 355 K-10/1,5-3-Z-Ex1-FM       | 2012 |
| 18051  | TERNO-S 355 K-15/2,2-3-Z              | 1000 |
| 18052  | TERNO-S 355 K-15/2,5-3-Z-Ex1          | 1634 |
| 18071  | TERNO-S 355 K-15/2-VTR-Z              | 1241 |
| 838752   | TERNO-S 355 K-15/2,2-3-Z-Ex1-FM       | 1975 |
| 18141  | TERNO-S 355 KB-10/1,5-3-P-Z           | 1015 |
| 18241  | TERNO-S 355 KB-10/1,5-3-L-Z           | 1015 |
| 18142  | TERNO-S 355 KB-10/1,3-3-P-Z-Ex1       | 1439 |
| 18242  | TERNO-S 355 KB-10/1,3-3-L-Z-Ex1       | 1439 |
| 18161  | TERNO-S 355 KB-10/1,25-VTR-P-Z        | 1091 |
| 18261  | TERNO-S 355 KB-10/1,25-VTR-L-Z        | 1091 |
| 838742   | TERNO-S 355 KB-10/1,5-3-P-Z-Ex1-FM    | 2032 |
| 838744   | TERNO-S 355 KB-10/1,5-3-L-Z-Ex1-FM    | 2032 |
| 18151  | TERNO-S 355 KB-15/2,2-3-P-Z           | 1020 |
| 18251  | TERNO-S 355 KB-15/2,2-3-L-Z           | 1020 |
| 18152  | TERNO-S 355 KB-15/2,5-3-P-Z-Ex1       | 1654 |
| 18252  | TERNO-S 355 KB-15/2,5-3-L-Z-Ex1       | 1654 |
| 18171  | TERNO-S 355 KB-15/2-VTR-P-Z           | 1261 |
| 18271  | TERNO-S 355 KB-15/2-VTR-L-Z           | 1261 |
| 838754   | TERNO-S 355 KB-15/2,2-3-P-Z-Ex1-FM    | 1995 |
| 838756   | TERNO-S 355 KB-15/2,2-3-L-Z-Ex1-FM    | 1995 |
| <b>Nerūdijantis plienas - EN 10088/1-3-95 (AISI 304) maisto, farmacijos pramonei</b> |                                       |      |
| 839028   | TERNO-S 355 K-10/1,5-3-AKV1           | 2174 |
| 839034   | TERNO-S 355 K-10/1,3-3-AKV1-Ex1       | 2635 |

AKV2

TERNO-S 355

AKV1

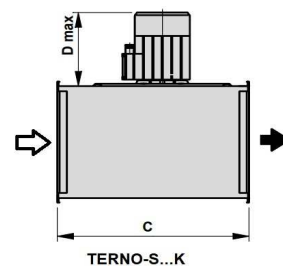
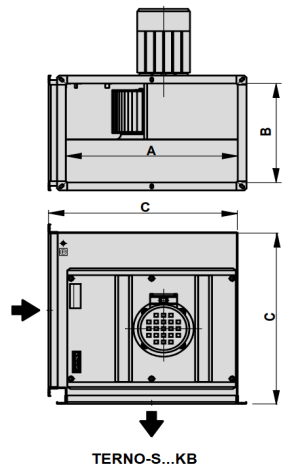
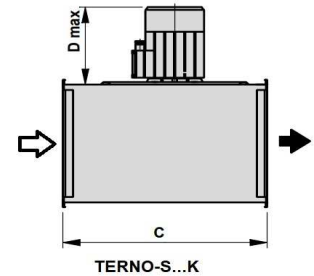



|  |                                       |      |
|--|---------------------------------------|------|
| 839040   | TERNO-S 355 K-10/1,25-VTR-AKV1        | 2415 |
| 839052   | TERNO-S 355 K-10/1,5-3-AKV1-Ex1-FM    | 3427 |
| 839058   | TERNO-S 355 K-15/2,2-3-AKV1           | 2179 |
| 839064   | TERNO-S 355 K-15/2,5-3-AKV1-Ex1       | 3116 |
| 839070   | TERNO-S 355 K-15/2-VTR-AKV1           | 2420 |
| 839082   | TERNO-S 355 K-15/2,2-3-AKV1-Ex1-FM    | 3390 |
| 839030   | TERNO-S 355 KB-10/1,5-3-P-AKV1        | 2241 |
| 839032   | TERNO-S 355 KB-10/1,5-3-L-AKV1        | 2241 |
| 839036   | TERNO-S 355 KB-10/1,3-3-P-AKV1-Ex1    | 2902 |
| 839038   | TERNO-S 355 KB-10/1,3-3-L-AKV1-Ex1    | 2902 |
| 839042   | TERNO-S 355 KB-10/1,25-VTR-P-AKV1     | 2482 |
| 839044   | TERNO-S 355 KB-10/1,25-VTR-L-AKV1     | 2482 |
| 839054   | TERNO-S 355 KB-10/1,5-3-P-AKV1-Ex1-FM | 3494 |
| 839056   | TERNO-S 355 KB-10/1,5-3-L-AKV1-Ex1-FM | 3494 |
| 839060   | TERNO-S 355 KB-15/2,2-3-P-AKV1        | 2247 |
| 839062   | TERNO-S 355 KB-15/2,2-3-L-AKV1        | 2247 |
| 839066   | TERNO-S 355 KB-15/2,5-3-P-AKV1-Ex1    | 3116 |
| 839068   | TERNO-S 355 KB-15/2,5-3-L-AKV1-Ex1    | 3116 |
| 839072   | TERNO-S 355 KB-15/2-VTR-P-AKV1        | 2487 |
| 839074   | TERNO-S 355 KB-15/2-VTR-L-AKV1        | 2487 |
| 839084   | TERNO-S 355 KB-15/2,2-3-P-AKV1-Ex1-FM | 3457 |
| 839086   | TERNO-S 355 KB-15/2,2-3-L-AKV1-Ex1-FM | 3457 |
| <b>Nerūdijantis plienas - EN 10088-95 (AISI 316) chemijos pramonei</b> |                                       |      |
| 839029   | TERNO-S 355 K-10/1,5-3-AKV2           | 2394 |
| 839035   | TERNO-S 355 K-10/1,3-3-AKV2-Ex1       | 2900 |
| 839041   | TERNO-S 355 K-10/1,25-VTR-AKV2        | 2635 |
| 839053   | TERNO-S 355 K-10/1,5-3-AKV2-Ex1-FM    | 3692 |
| 839059   | TERNO-S 355 K-15/2,2-3-AKV2           | 2400 |
| 839065   | TERNO-S 355 K-15/2,5-3-AKV2-Ex1       | 2938 |
| 839071   | TERNO-S 355 K-15/2-VTR-AKV2           | 2640 |
| 839083   | TERNO-S 355 K-15/2,2-3-AKV2-Ex1-FM    | 3655 |
| 839031   | TERNO-S 355 KB-10/1,5-3-P-AKV2        | 2469 |
| 839033   | TERNO-S 355 KB-10/1,5-3-L-AKV2        | 2469 |
| 839037   | TERNO-S 355 KB-10/1,3-3-P-AKV2-Ex1    | 2975 |
| 839039   | TERNO-S 355 KB-10/1,3-3-L-AKV2-Ex1    | 3174 |
| 839043   | TERNO-S 355 KB-10/1,25-VTR-P-AKV2     | 3174 |
| 839045   | TERNO-S 355 KB-10/1,25-VTR-L-AKV2     | 2710 |
| 839055   | TERNO-S 355 KB-10/1,5-3-P-AKV2-Ex1-FM | 3767 |
| 839057   | TERNO-S 355 KB-10/1,5-3-L-AKV2-Ex1-FM | 3767 |
| 839061   | TERNO-S 355 KB-15/2,2-3-P-AKV2        | 2475 |
| 839063   | TERNO-S 355 KB-15/2,2-3-L-AKV2        | 2475 |
| 839067   | TERNO-S 355 KB-15/2,5-3-P-AKV2-Ex1    | 3389 |
| 839069   | TERNO-S 355 KB-15/2,5-3-L-AKV2-Ex1    | 3389 |
| 839073   | TERNO-S 355 KB-15/2-VTR-P-AKV2        | 2715 |
| 839075   | TERNO-S 355 KB-15/2-VTR-L-AKV2        | 2715 |
| 839085   | TERNO-S 355 KB-15/2,2-3-P-AKV2-Ex1-FM | 3730 |
| 839087   | TERNO-S 355 KB-15/2,2-3-L-AKV2-Ex1-FM | 3730 |
| <b>CINKUOTAS PLIENAS</b>   |                                       |      |
| 19041  | TERNO-S 400 K-10/1,5-3-Z              | 1152 |
| 19042  | TERNO-S 400 K-10/1,3-3-Z-Ex1          | 1609 |
| 19061  | TERNO-S 400 K-10/2-VTR-Z              | 1596 |
| 838776   | TERNO-S 400 K-10/1,5-3-Z-Ex1-FM       | 2202 |
| 19051  | TERNO-S 400 K-15/3-3-Z                | 1194 |
| 19052  | TERNO-S 400 K-15/2,5-3-Z-Ex1          | 1823 |
| 19071  | TERNO-S 400 K-15/3,4-VTR-Z            | 1737 |
| 838788   | TERNO-S 400 K-15/3-3-Z-Ex1-FM         | 2264 |
| 832903   | TERNO-S 400 K-15/5,5-3-Z              | 1416 |
| 832904   | TERNO-S 400 K-15/3,6-3-Z-Ex1          | 1857 |
| 830769   | TERNO-S 400 K-15A/3-3-Z               | 1194 |
| 830770   | TERNO-S 400 K-15A/2,5-3-Z-Ex1         | 1823 |
| 830772   | TERNO-S 400 K-15A/3,4-VTR-Z           | 1737 |
| 838800   | TERNO-S 400 K-15A/3-3-Z-Ex1-FM        | 2264 |
| 19141  | TERNO-S 400 KB-10/1,5-3-P-Z           | 1177 |
| 19241  | TERNO-S 400 KB-10/1,5-3-L-Z           | 1177 |
| 19142  | TERNO-S 400 KB-10/1,3-3-P-Z-Ex1       | 1634 |
| 19242  | TERNO-S 400 KB-10/1,3-3-L-Z-Ex1       | 1634 |
| 19161  | TERNO-S 400 KB-10/2-VTR-P-Z           | 1621 |
| 19261  | TERNO-S 400 KB-10/2-VTR-L-Z           | 1621 |
| 838778   | TERNO-S 400 KB-10/1,5-3-P-Z-Ex1-FM    | 2227 |

AKV2

TERNO-S 400

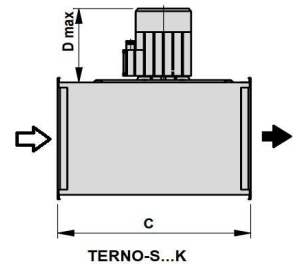
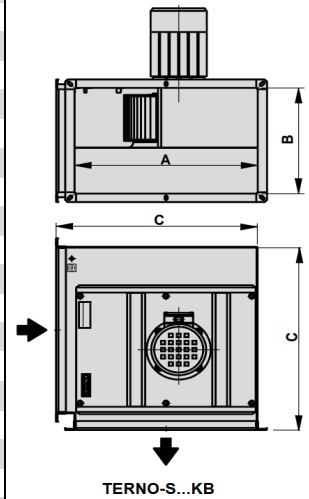

|        |                                    |      |
|--------|------------------------------------|------|
| 838780 | TERNO-S 400 KB-10/1,5-3-L-Z-Ex1-FM | 2227 |
| 19151  | TERNO-S 400 KB-15/3-3-P-Z          | 1220 |
| 19251  | TERNO-S 400 KB-15/3-3-L-Z          | 1220 |
| 19152  | TERNO-S 400 KB-15/2,5-3-P-Z-Ex1    | 1848 |
| 19252  | TERNO-S 400 KB-15/2,5-3-L-Z-Ex1    | 1848 |
| 19171  | TERNO-S 400 KB-15/3,4-VTR-P-Z      | 1763 |
| 19271  | TERNO-S 400 KB-15/3,4-VTR-L-Z      | 1763 |
| 838790 | TERNO-S 400 KB-15/3-3-P-Z-Ex1-FM   | 2290 |
| 838792 | TERNO-S 400 KB-15/3-3-L-Z-Ex1-FM   | 2290 |
| 832905 | TERNO-S 400 KB-15/5,5-3-P-Z        | 1441 |
| 832907 | TERNO-S 400 KB-15/5,5-3-L-Z        | 1441 |
| 832906 | TERNO-S 400 KB-15/3,6-3-P-Z-Ex1    | 1882 |
| 832908 | TERNO-S 400 KB-15/3,6-3-L-Z-Ex1    | 1882 |
| 830779 | TERNO-S 400 KB-15A/3-3-P-Z         | 1220 |
| 830775 | TERNO-S 400 KB-15A/3-3-L-Z         | 1220 |
| 830780 | TERNO-S 400 KB-15A/2,5-3-P-Z-Ex1   | 1848 |
| 830776 | TERNO-S 400 KB-15A/2,5-3-L-Z-Ex1   | 1848 |
| 830785 | TERNO-S 400 KB-15A/3,4-VTR-P-Z     | 1763 |
| 830783 | TERNO-S 400 KB-15A/3,4-VTR-L-Z     | 1763 |
| 838802 | TERNO-S 400 KB-15A/3-3-P-Z-Ex1-FM  | 2290 |
| 838804 | TERNO-S 400 KB-15A/3-3-L-Z-Ex1-FM  | 2290 |

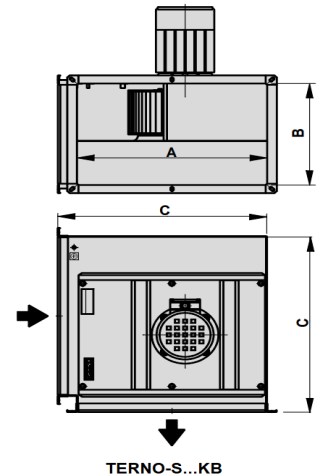

AKV1

*Nerūdijantis plienas - EN 10088/1-3-95 (AISI 304) maisto, farmacijos pramonei*

|        |                                       |      |
|--------|---------------------------------------|------|
| 839106 | TERNO-S 400 K-10/1,5-3-AKV1           | 2534 |
| 839112 | TERNO-S 400 K-10/1,3-3-AKV1-Ex1       | 3267 |
| 839118 | TERNO-S 400 K-10/2-VTR-AKV1           | 3111 |
| 839130 | TERNO-S 400 K-10/1,5-3-AKV1-Ex1-FM    | 3860 |
| 839136 | TERNO-S 400 K-15/3-3-AKV1             | 2576 |
| 839142 | TERNO-S 400 K-15/2,5-3-AKV1-Ex1       | 3481 |
| 839148 | TERNO-S 400 K-15/3,4-VTR-AKV1         | 3187 |
| 839160 | TERNO-S 400 K-15/3-3-AKV1-Ex1-FM      | 3923 |
| 839166 | TERNO-S 400 K-15/5,5-3-AKV1           | 2798 |
| 839172 | TERNO-S 400 K-15/3,6-3-AKV1-Ex1       | 3515 |
| 839178 | TERNO-S 400 K-15A/3-3-AKV1            | 2576 |
| 839184 | TERNO-S 400 K-15A/2,5-3-AKV1-Ex1      | 3481 |
| 839190 | TERNO-S 400 K-15A/3,4-VTR-AKV1        | 3187 |
| 839202 | TERNO-S 400 K-15A/3-3-AKV1-Ex1-FM     | 3923 |
| 839108 | TERNO-S 400 KB-10/1,5-3-P-AKV1        | 2618 |
| 839110 | TERNO-S 400 KB-10/1,5-3-L-AKV1        | 2618 |
| 839114 | TERNO-S 400 KB-10/1,3-3-P-AKV1-Ex1    | 3351 |
| 839116 | TERNO-S 400 KB-10/1,3-3-L-AKV1-Ex1    | 3351 |
| 839120 | TERNO-S 400 KB-10/2-VTR-P-AKV1        | 3195 |
| 839122 | TERNO-S 400 KB-10/2-VTR-L-AKV1        | 3195 |
| 839132 | TERNO-S 400 KB-10/1,5-3-P-AKV1-Ex1-FM | 3944 |
| 839134 | TERNO-S 400 KB-10/1,5-3-L-AKV1-Ex1-FM | 3944 |
| 839138 | TERNO-S 400 KB-15/3-3-P-AKV1          | 2660 |
| 839140 | TERNO-S 400 KB-15/3-3-L-AKV1          | 2660 |
| 839144 | TERNO-S 400 KB-15/2,5-3-P-AKV1-Ex1    | 3565 |
| 839146 | TERNO-S 400 KB-15/2,5-3-L-AKV1-Ex1    | 3565 |
| 839150 | TERNO-S 400 KB-15/3,4-VTR-P-AKV1      | 3271 |
| 839152 | TERNO-S 400 KB-15/3,4-VTR-L-AKV1      | 3271 |
| 839162 | TERNO-S 400 KB-15/3-3-P-AKV1-Ex1-FM   | 4007 |
| 839164 | TERNO-S 400 KB-15/3-3-L-AKV1-Ex1-FM   | 4007 |
| 839168 | TERNO-S 400 KB-15/5,5-3-P-AKV1        | 2882 |
| 839170 | TERNO-S 400 KB-15/5,5-3-L-AKV1        | 2882 |
| 839174 | TERNO-S 400 KB-15/3,6-3-P-AKV1-Ex1    | 3599 |
| 839176 | TERNO-S 400 KB-15/3,6-3-L-AKV1-Ex1    | 3599 |
| 839180 | TERNO-S 400 KB-15A/3-3-P-AKV1         | 2660 |
| 839182 | TERNO-S 400 KB-15A/3-3-L-AKV1         | 2660 |
| 839186 | TERNO-S 400 KB-15A/2,5-3-P-AKV1-Ex1   | 3541 |
| 839188 | TERNO-S 400 KB-15A/2,5-3-L-AKV1-Ex1   | 3541 |
| 839192 | TERNO-S 400 KB-15A/3,4-VTR-P-AKV1     | 3271 |
| 839194 | TERNO-S 400 KB-15A/3,4-VTR-L-AKV1     | 3271 |
| 839204 | TERNO-S 400 KB-15A/3-3-P-AKV1-Ex1-FM  | 4007 |
| 839206 | TERNO-S 400 KB-15A/3-3-L-AKV1-Ex1-FM  | 4007 |

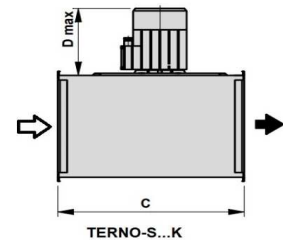

AKV2

*Nerūdijantis plienas - EN 10088-95 (AISI 316) chemijos pramonei*

|        |                                    |      |
|--------|------------------------------------|------|
| 839107 | TERNO-S 400 K-10/1,5-3-AKV2        | 2798 |
| 839113 | TERNO-S 400 K-10/1,3-3-AKV2-Ex1    | 3583 |
| 839119 | TERNO-S 400 K-10/2-VTR-AKV2        | 3375 |
| 839131 | TERNO-S 400 K-10/1,5-3-AKV2-Ex1-FM | 4176 |

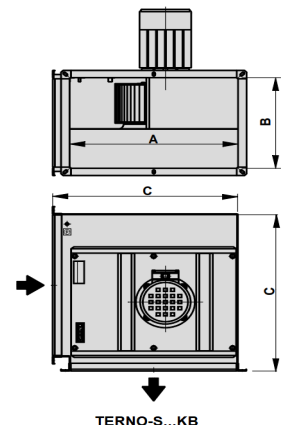

|        |                                       |      |
|--------|---------------------------------------|------|
| 839137 | TERNO-S 400 K-15/3-3-AKV2             | 2840 |
| 839143 | TERNO-S 400 K-15/2,5-3-AKV2-Ex1       | 3797 |
| 839149 | TERNO-S 400 K-15/3,4-VTR-AKV2         | 3450 |
| 839161 | TERNO-S 400 K-15/3-3-AKV2-Ex1-FM      | 4238 |
| 839167 | TERNO-S 400 K-15/5,5-3-AKV2           | 3061 |
| 839173 | TERNO-S 400 K-15/3,6-3-AKV2-Ex1       | 3831 |
| 839179 | TERNO-S 400 K-15A/3-3-AKV2            | 2840 |
| 839185 | TERNO-S 400 K-15A/2,5-3-AKV2-Ex1      | 3797 |
| 839191 | TERNO-S 400 K-15A/3,4-VTR-AKV2        | 3450 |
| 839203 | TERNO-S 400 K-15A/3-3-AKV2-Ex1-FM     | 4238 |
| 839109 | TERNO-S 400 KB-10/1,5-3-P-AKV2        | 2892 |
| 839111 | TERNO-S 400 KB-10/1,5-3-L-AKV2        | 2892 |
| 839115 | TERNO-S 400 KB-10/1,3-3-P-AKV2-Ex1    | 3677 |
| 839117 | TERNO-S 400 KB-10/1,3-3-L-AKV2-Ex1    | 3677 |
| 839121 | TERNO-S 400 KB-10/2-VTR-P-AKV2        | 3469 |
| 839123 | TERNO-S 400 KB-10/2-VTR-L-AKV2        | 3469 |
| 839133 | TERNO-S 400 KB-10/1,5-3-P-AKV2-Ex1-FM | 4270 |
| 839135 | TERNO-S 400 KB-10/1,5-3-L-AKV2-Ex1-FM | 4270 |
| 839139 | TERNO-S 400 KB-15/3-3-P-AKV2          | 2934 |
| 839141 | TERNO-S 400 KB-15/3-3-L-AKV2          | 2934 |
| 839145 | TERNO-S 400 KB-15/2,5-3-P-AKV2-Ex1    | 3892 |
| 839147 | TERNO-S 400 KB-15/2,5-3-L-AKV2-Ex1    | 3892 |
| 839151 | TERNO-S 400 KB-15/3,4-VTR-P-AKV2      | 3545 |
| 839153 | TERNO-S 400 KB-15/3,4-VTR-L-AKV2      | 3545 |
| 839163 | TERNO-S 400 KB-15/3-3-P-AKV2-Ex1-FM   | 4333 |
| 839165 | TERNO-S 400 KB-15/3-3-L-AKV2-Ex1-FM   | 4333 |
| 839169 | TERNO-S 400 KB-15/5,5-3-P-AKV2        | 3155 |
| 839171 | TERNO-S 400 KB-15/5,5-3-L-AKV2        | 3155 |
| 839175 | TERNO-S 400 KB-15/3,6-3-P-AKV2-Ex1    | 3925 |
| 839177 | TERNO-S 400 KB-15/3,6-3-L-AKV2-Ex1    | 3925 |
| 839181 | TERNO-S 400 KB-15A/3-3-P-AKV2         | 2934 |
| 839183 | TERNO-S 400 KB-15A/3-3-L-AKV2         | 2934 |
| 839187 | TERNO-S 400 KB-15A/2,5-3-P-AKV2-Ex1   | 3892 |
| 839189 | TERNO-S 400 KB-15A/2,5-3-L-AKV2-Ex1   | 3892 |
| 839193 | TERNO-S 400 KB-15A/3,4-VTR-P-AKV2     | 3545 |
| 839195 | TERNO-S 400 KB-15A/3,4-VTR-L-AKV2     | 3545 |
| 839205 | TERNO-S 400 KB-15A/3-3-P-AKV2-Ex1-FM  | 4333 |
| 839207 | TERNO-S 400 KB-15A/3-3-L-AKV2-Ex1-FM  | 4333 |

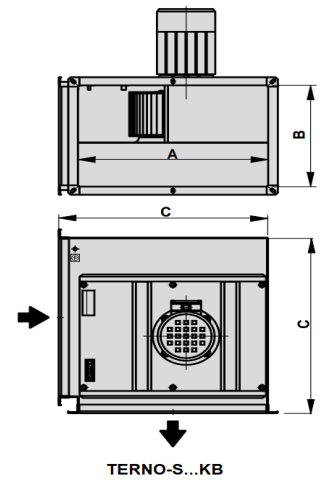
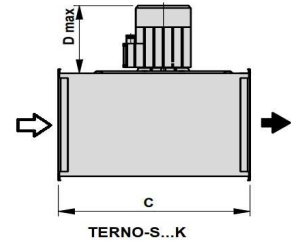

Kainos pateiktos Eur be PVM